

MODELING OF REACTIVE DISTILLATION FOR ACETIC ACID ESTERIFICATION

Chathurangani Wathsala Kandanapitiya

138002B



University of Moratuwa, Sri Lanka.
Electronic Theses & Dissertations
www.lib.mrt.ac.lk

Degree of Master of Science

Department of Chemical and Process Engineering

University of Moratuwa
Sri Lanka

February 2016

MODELING OF REACTIVE DISTILLATION FOR ACETIC ACID ESTERIFICATION

Chathurangani Wathsala Kandanapitiya

138002B



University of Moratuwa, Sri Lanka.
Electronic Theses & Dissertations
www.lib.mrt.ac.lk

Thesis submitted in partial fulfillment for the degree of Master
of Science

Department of Chemical and Process Engineering

University of Moratuwa
Sri Lanka

February 2016

DECLARATION

I declare that this is my own work and this thesis does not incorporate without acknowledgement any material previously submitted for a Degree or Diploma in any other University or institute of higher learning and to the best of my knowledge and belief it does not contain any material previously published or written by another person except where the acknowledgement is made in the text.

Also, I hereby grant to University of Moratuwa the non-exclusive right to reproduce and distribute my thesis, in whole or in part in print, electronic or other medium. I retain the right to use this content in whole or part in future works.

Signature:

Date:



University of Moratuwa, Sri Lanka.
Electronic Theses & Dissertations
www.lib.mrt.ac.lk

The above candidate has carried out research for the Master's thesis under my supervision.

Signature of the supervisor:

Date

DEDICATION

I dedicate this thesis and to my mother who has brought me thus far on her shoulders and to my husband supporting in every way in my life.



University of Moratuwa, Sri Lanka.
Electronic Theses & Dissertations
www.lib.mrt.ac.lk

ACKNOWLEDGEMENTS

I would like to express my deepest gratitude to main Supervisor Dr.(Ms)M Y Gunasekera for her guidance, understanding, kind support, encouraging advices, criticism, and valuable discussions throughout my thesis.

I am greatly indebted other Supervisors to Dr. N Narayana, and Prof. Padma Amarasinghe for giving valuable instructions and encouraging me.

My deep sense of gratitude goes to former Head of the Department Dr. A.D.U.S. Amarasinghe and Dr. P.G. Rathnasiri, Head of the Department of Chemical and Process Engineering, University of Moratuwa.

Again I would like to thank Dr. M Y Gunasekara for her guidance in thesis writing.

Special thanks go to Mr. Anushka Perera for his initial guidance matlab environment.

I would also like to thank SRC grant (RC/LT/2012/10) for funding this research "Modeling of reactive distillation for acetic acid esterification."



University of Moratuwa, Sri Lanka.
Electronic Theses & Dissertations
www.lib.mrt.ac.lk

I wish to thank Miss. Bhagya Herath and Miss Thamali Jayawickramawho have always made valuable comment suggestions to make this research successful.

Finally I take this opportunity to acknowledge all members of the academic staff of Department of Chemical and Process Engineering for helping in various ways.

ABSTRACT

Reactive distillation is the combination of unit operations reactor and distillation column into one unit. Reactive distillation offers higher conversions, reacting away azeotropes, heat integration, product selectivity and significant capital saving. Reactive distillation is industrially applied for many reactions. Equilibrium and non-equilibrium models are commonly used for modeling of reactive distillation. The equations used for modeling are called MESH equations. M-material E-equilibrium S-summation H-enthalpy. The model equations were developed for a reactive distillation unit consisting of a batch reactor and one stage distillation unit. The model was applied in an ethanol and acetic acid esterification reaction considering homogeneous and heterogeneous reaction kinetics. Nineteen modelling equations were developed with 22 variables and three variables being specified. The differential equations were converted into algebraic equations by applying forward Euler method. Bubble point program is used to find equilibrium vapour composition and temperature. The initial composition of the reactor and the condenser as 45% acetic acid 45% ethanol, 1% water. The holdups are assumed as 5000 moles and 100 moles respectively. Simulations for solving of algebraic equations and bubble point temperature calculation were developed in matlab environment. Simulation results were observed for different 0.825 to 0.99 L₀/V₁ ratios. Dynamics of reactor and condenser compositions and ethyl acetate purity in the accumulated distillate were simulated for different L₀/V₁ ratios. Maximum ethyl acetate percentage in the accumulated distillate increases with increase in L₀/V₁ ratio. The dynamics of reactor temperature and conversion of acetic acid show high conversions of acetic acid in higher reflux ratios. Further the reactor heat load and batch time also increase with increase in L₀/V₁ ratio. Average production rate reduces with increasing L₀/V₁ ratio. The simulation was also done for heterogeneous reaction kinetics using Langmuir-Hinshelwood kinetic model. The variation of condenser composition, ethyl acetate percentage in the accumulated distillate, dynamics of reactor temperature and conversion of acetic acid were studied with time. Modelled results show that increase in the L₀/V₁ ratio increase the reactor batch time, although no variation in the average production rate is observed.

Key words: Reactive distillation, modelling, Simulation, Esterification, ethyl acetate

TABLE OF CONTENT

DECLARATION	i
DEDICATION	ii
ACKNOWLEDGEMENT	iii
ABSTRACT	iv
TABLE OF CONTENT	v
LIST OF FIGURES	vi
LIST OF TABLES	vii
LIST OF ABBREVIATION	viii
1.0 INTRODUCTION	1
1.1 Background	1
1.2 Research Objectives and Scope	3
1.3 Thesis Structure	4
2.0 LITERATURE SURVEY	
2.1. Introduction	5
2.2. Benefits of Reactive Distillation	8
2.3. Commercial applications	9
2.4. Application of Reactive distillation in Esterification	10
2.5. Reactive Distillation Mathematical Models	11
2.5.1. Equilibrium stage modeling of reactive distillation	12
2.5.2. Non equilibrium stage modeling of reactive distillation	15

3.0 DEVELOPMENT OF REACTIVE DISTILLATION MODEL	
3.1. Model Apparatus	18
3.2. Reaction rate	19
3.3. Development of model equations for condenser reflux drum	21
3.4. Development of model equations for the Reactor batch	24
3.5. Equilibrium relationships	27
3.6. Enthalpy relationships	27
3.7. Equilibrium data	28
3.8. Bubble Temperature Parameters	28
3.9 Flow chart for Bubble Temperature Estimation	30
3.10 Flow chart for dynamic simulation of RBD column	31
4.0 MODELLING ACETIC ACID ESTERIFICATION IN REACTIVE BATCH DISTILLATION	
4.1 Reaction Kinetics	32
4.1.1 Homogeneous Reaction Kinetics	32
4.1.2 Heterogeneous Reaction Kinetics	33
4.2 Reactive Distillation Design System	34
4.3 Material and enthalpy balance model equations	35
4.4 Degrees of Freedom	36
4.5 Algebraic equations	38
4.6 Bubble Temperature Calculation	39
5.0 REACTIVE BATCH DISTILLATION MODELLING AND SIMULATION RESULTS AND DISCUSSION	
5.1 Homogeneous Reaction Kinetics	41
5.1.1 Reactor composition variation with time	42
5.1.2 Condenser Composition variation with time	43
5.1.3 Ethyl acetate purity in the accumulated distillate	46
5.1.4 Dynamics of reactor temperature	47

5.1.5 Conversion of Acetic acid	48
5.2 Heterogeneous Reaction Kinetics Model Simulation	48
5.2.1 Condenser composition at various reflux ratios	49
5.2.2 The variation of process parameters with reflux ratios	51
5.2.3 Effect of Reflux ratio on Ethyl Acetate Production	53
5.2.4 Average ethyl acetate production rate for initial reactant Composition of acetic acid to ethanol ratio of one	54
5.3 Comparison with literature results	55
6.0 CONCLUSIONS AND RECOMMENDATIONS	
6.1 Conclusions	56
6.2 Recommendations for future work	57
REFERANCES	58
Appendix A: An example calculation of parameters used for bubble point calculation	63
Appendix B: Bubble point temperature determination example calculation	68
Appendix C: Solving model equations	73
Appendix D: M file for solving algebraic equations in reactive distillation	82
Appendix E: M file to calculate bubble point temperature	84
Appendix F: M file for heterogeneous catalyst	86



University of Moratuwa, Sri Lanka.
Electronic Theses & Dissertations
www.lib.mrt.ac.lk

LIST OF FIGURES

FIGURES	Page
Figure 2.1 Comparison of reactive distillation with conventional process	6
Figure 2.2 Processing schemes for Methyl acetate esterification reaction	10
Figure 2.3 Equilibrium stage in a reactive distillation column	12
Figure 2.4 Non Equilibrium (NEQ) stage in a reactive distillation column	15
Figure 3.1 Single stage batch distillation process	19
Figure 3.2 Flow chart for Bubble temperature Estimation	30
Figure 3.3 Flow chart for dynamic modeling of reactive batch distillation column	31
Figure 5.1 Reactor composition variation at reflux 99	42
Figure 5.2 Condenser composition $L_0/V_1=0.825$	43
Figure 5.3 Condenser composition $L_0/V_1=0.85$	43
Figure 5.4 Condenser composition $L_0/V_1=0.9$	43
Figure 5.5 Condenser composition $L_0/V_1=0.95$	43
Figure 5.6 Condenser composition $L_0/V_1=0.975$	44
Figure 5.7 Condenser composition $L_0/V_1=0.99$	44
Figure 5.8 Ethyl acetate purity in the accumulated distillate	46
Figure 5.9 Dynamics of reactor temperature	47
Figure 5.10 Dynamics of conversion of acetic acid with time	48
Figure 6.1 Condenser composition for $L_0/V_1=0.7$	49
Figure 6.2 Condenser composition for $L_0/V_1=0.825$	49

Figure 6.3	Condenser composition for $L_0/V_1=0.85$	49
Figure 6.4	Condenser composition for $L_0/V_1=0.9$	49
Figure 6.5	Condenser composition for $L_0/V_1=0.95$	50
Figure 6.6	Condenser composition for $L_0/V_1=0.975$	50
Figure 6.7	Condenser composition for $L_0/V_1=0.99$	50
Figure 6.8	Ethyl Acetate percentage in the accumulated distillate -heterogeneous catalyst	51
Figure 6.9	Dynamics of reactor temperature-heterogeneous catalyst	52
Figure 6.10	Conversion of Acetic acid-heterogeneous catalyst	52



University of Moratuwa, Sri Lanka.
Electronic Theses & Dissertations
www.lib.mrt.ac.lk

LIST OF TABLES

TABLES		PAGE NO
Table 4.1	Number of independent equations	36
Table 4.2	The variables in modeling equations	37
Table 5.1	Reflux ratio R values	41
Table 5.2	Effect of reflux ratio on EAc production	45
Table 5.3	Effect of reflux ratio on EAc production-heterogeneous catalyst	53
Table 5.4	Ethyl acetate production rates for various L0/V1 for acetic acid to ethanol initial reactant ratio of 1.0 with heterogeneous reaction kinetics	54



University of Moratuwa, Sri Lanka.
Electronic Theses & Dissertations
www.lib.mrt.ac.lk

LIST OF ABBREVIATIONS

Abbreviation	Description
DAE	differential-algebraic equations
EQ	equilibrium
MeOH	methanol
EAc	ethyl acetate
AcOH	acetic acid
MS	Maxwell Stefan
MTBE	methyl tert-butyl ether
NEQ	non-equilibrium
RD	reactive distillation
TAME	tertiary amyl ether



NOTATIONS

A	molar holdup(mol)
D	distillate flow rate(mol/s)
V	vapor flow rate (mol/s)
v	volume of liquid
L_0	Liquid flow rate (mol/s)
r	rate of reaction(mol/m ³ .s)
x_i	mol fraction of i th component in the liquid phase
y_i	mol fraction of i th component in the vapor phase

Q_0	heat duty on condenser-reflux drum(J/s)
Q_1	heat duty on reboiler(J/s)
ΔH_r	heat of reaction (J/mol)
H_v	Vapor enthalpy (J/mol)
H_L	Liquid enthalpy (J/mol)
P	pressure(N/m ²)
N_i	moles of i th component formed
c	Number of components
P_i^{sat}	Saturation temperature of component i(N/m ²)
i	component number
C_i	concentration of i th component
a	interfacial area, m ²
c	number of components, dimensionless
$D_{i,k}$	Maxwell-Stefan diffusivity, m ² s ⁻¹
E	energy flux, Wm ⁻²
\dot{E}	Energy transfer rate, J s ⁻¹
FV	vapor feed stream, mo l s ⁻¹
FL	liquid feed stream, mo l s ⁻¹
f	component feed stream, mo l s ⁻¹
h	heat transfer coefficient, Wm ⁻² K ⁻¹
H	molar enthalpy, J mol ⁻¹



k_1	pseudo-first-order reaction rate constant, s^{-1}
K	vapor liquid equilibrium constant, dimensionless
L	liquid flow rate, $mol\ s^{-1}$
N_i	molar flux of species i , $mol\ m^{-2}\ s^{-1}$
N	Mass transfer rate, $mol\ s^{-1}$
Q	heat duty, $J\ s^{-1}$
r	number of reactions, dimensionless
r_j	ratio of side stream flow to inter stage flow on stage j , dimensionless
$R_{m,j}$	reaction rate, $mol\ m^{-3}\ s^{-1}$
R	gas constant, $J\ mol^{-1}\ K^{-1}$
t	time, s
T	temperature, K
U	molar hold-up, mol
V	vapor flow rate, $mol\ s^{-1}$
x	mole fraction in the liquid-phase, dimensionless
y	mole fraction in the vapor-phase, dimensionless



University of Moratuwa, Sri Lanka.
 Electronic Theses & Dissertations
www.lib.mrt.ac.lk

GREEK LETTERS

ε	reaction volume, m^3
κ	mass transfer coefficient, m s^{-1}
μ	chemical potential, J mol^{-1}
η	distance along diffusion path, dimensionless

SUBSCRIPTS

i	component index
I	referring to interface
j	stage index
k	alternative component index
m	reaction index

SUPERSCRIPTS

F	referring to feed stream
L	referring to liquid-phase
V	referring to vapor- phase



University of Moratuwa, Sri Lanka.
Electronic Theses & Dissertations
www.lib.mrt.ac.lk



University of Moratuwa, Sri Lanka.
Electronic Theses & Dissertations
www.lib.mrt.ac.lk

CHAPTER 1

INTRODUCTION

1.1 Background

Reactive distillation is the combination of reaction and distillation operations into one unit operation. By combining two unit operations into one, the process is intensified reducing the inventory of chemicals involved in the process and thereby reducing the hazards associated with large quantities. Further, it reduces capital costs and production costs as well. Reactive distillation offers less waste and fewer byproducts and also reduces recycle costs for excess reactants (Lee and Dudukovic, 1998).

Reactive distillation is now an industrially established process (Berman, Isbenjian, Sedoff and Othmer, 1948) which can be used for various reactions such as Acetalation, Aldolcondensation, Alkylation, Amination, Dehydration, Esterification, Etherification, Hydrolysis, Isomerization, Oligomerization and Transesterification (Kumar, 2010).

In reversible reactions higher conversions can be achieved in reactive distillation process by shifting the reaction equilibrium to the right or on to the product side. Further in reactive distillation the products formed are continuously separated and possible side reactions are eliminated. Higher selectivity can be achieved due to elimination of these possible side reactions (Simandl and Svrcek, 1991; Raghavan, Radhakrishnan and Sirinivasan, 2011). Azeotropic mixtures can also be eliminated as the products go continuously to the vapor phase. Further, the heat of reaction can be used for vaporizing the reaction mixture for distillation.

Reactive distillation has some constraints. The reactants and products should have suitable volatilities to maintain high concentrations of reactants and low concentrations of products in the reaction zone in the reactor. If the residence time for the reaction is high a large column size and large tray holdups may be required for distillation process. Pressure and temperature required for distillation process may be different from the temperature and pressure required for reaction to take place.

One of the main advantages of reactive distillation is the reduction in capital cost. An application in the industry is replacing the traditional reactor and distillation column system

with reactive distillation achieving a fivefold reduction of the capital investment and energy consumption (Kumar, 2010).

Reactive distillation is mainly of two types namely batch and continuous. The modeling of reactive distillation process for both batch and continuous is very rigorous as it has complex interactions between vapor-liquid equilibrium, vapor liquid mass transfer, intra-catalyst diffusion and chemical kinetics. The research work in literature for batch reactive distillation modeling is less compared to that of continuous reactive distillation (Taylor and Krishna, 2000). Most of the modeling work on batch reactive distillation in literature has been done considering several distillation separation stages (Patel, Singh, Pareek, and Tade, 2007).

Esterification of acetic acid with ethanol produces ethyl acetate which is one of the widely used solvents in surface coating and thinners manufacturing industry in Sri Lanka. It is also used in manufacturing flavors and essences, flexible packaging, wine, adhesives, cleaning fluids, inks, nail polish removers and silk, coated papers, explosives, artificial leather, photographic films and plates. The ethyl acetate production process involves reaction and distillation operations where application of reactive distillation could be very beneficial.



University of Moratuwa, Sri Lanka
Electronic Theses & Dissertations
www.lib.mrt.ac.lk

1.2 Research Objectives and Scope

Main objectives of the research:

- Development of a mathematical model to model reactive distillation for a batch reactive distillation process with single stage separation.
- Application of the model using homogeneous reaction kinetics for acetic acid esterification with ethanol
- Application of the model using heterogeneous kinetics developed for an ion exchange resin catalyst for acetic acid esterification reaction with ethanol.
- Identification of most suitable operation conditions for reactive distillation.



University of Moratuwa, Sri Lanka.
Electronic Theses & Dissertations
www.lib.mrt.ac.lk

1.2 Thesis structure

This thesis contains five chapters and chapter one is an overview of the background of the research, research objectives and the structure of thesis.

Literature Survey in Chapter two includes research works carried out related to reactive distillation, esterification applications in reactive distillation and different types of mathematical models developed for reactive distillation by various researchers.

Chapter three explains model equations development for a batch reactive distillation system. It contains total mole balance, component wise mole balance, and overall enthalpy balance for condenser reflux drum and reactor batch. It further includes equilibrium relationships, enthalpy relationships, reaction kinetics, degrees of freedom, equilibrium data and methodology for the bubble temperature calculation.

Chapter four describes modeling acetic acid esterification in reactive batch distillation considering homogeneous and heterogeneous reaction kinetics.

The results of application of the model in acetic acid and ethanol esterification reaction are presented in chapter five. Reactor compositions and condenser compositions at different reflux ratios are presented in this chapter. The results of application of the reactive distillation model with homogeneous as well as heterogeneous reaction kinetics are also shown. Finally, chapter six presents conclusions and recommendations for future work.



CHAPTER2

LITERATURE SURVEY

2.1 Introduction

There is an increasing demand for processes which need less energy, produce zero waste chemicals and optimum use of chemicals in various industries. Process intensification is one of the new approaches which uses methods (software) and equipments (hardware) leading to compact, safe, energy-efficient, and environment-friendly sustainable processes.

Reactive distillation, spinning disk reactor, static mixer reactor, monolithic reactor, micro reactor, static mixer, compact heat exchanger, rotating packed bed, centrifugal absorber, heat integrated reactor, reactive separation, reactive communiton, reactive extrusion, fuel cell, membrane adsorption are some examples which use process intensification. Reactive distillation (RD) is the integration of chemical reaction and separation of products and reactants at the same place and same time where conventionally a reactor and a distillation column are required separately. It has been used in a small number of industrial applications for many years, but during last decade an increase in both research and in applications have been observed (Muhammad, Arfaj, Luyben, 2002).



University of Moratuwa, Sri Lanka
Electronic Theses & Dissertations
www.lib.mrt.ac.lk

In comparison to conventional reactor–separator sequence, reactive distillation allows for higher reactant conversion, product selectivity and energy savings with favorable investment and operating costs (Kenig et al., 2001, Raghavan 2011). However, there are several constraints that, limit the successful application of RD, such as complex design, difficulty in scaling- up, advanced process control, difficulty in determining operating range for distillation and reaction and proper boiling point sequence, and providing proper residence time characteristics (Taylor et al., 2000).

Optimal performance of reactive distillation processes depends strongly on a reliable process design, properly selected column internals, feed locations, catalyst choice, as well as on a sufficient understanding of the process behavior that is considerably more complex than that of conventional reactor–separator sequences. The introduction of separation function within the reaction zone leads to complex interactions between vapor-liquid equilibrium, vapour liquid mass transfer, intra-catalyst diffusion (for heterogeneously catalyzed process) and chemical kinetics. Such interactions have been

shown to lead to the phenomenon of multiple steady state and complex dynamics, which have been verified in experimental, laboratory and pilot plant units (Chen, Huss, Malone, & Doherty, 2002; Jacobs and Krishna, 1993; Mohl et al, 1999; Singh, Kumar, & Kaistha, 2005). Therefore, the design of reactive distillation processes requires reliable and accurate models that enable the process engineer to significantly decrease the expensive and time consuming experimental work.

The figure 2.1(a) and Figure 2.1(b) illustrate an example comparing reactive distillation process and the conventional reactor and distillation separate processes considering the reversible reaction $A + B \rightleftharpoons C + D$ where the boiling points of the components follow the sequence A, C, D, B. The traditional process consists of reactor followed by a sequence of distillation columns as shown in figure 2.1(a). The mixture of A and B is fed to the reactor, where an equilibrium is reached in the presence of a catalyst. A series of distillation columns are required to produce pure C and D. The unreacted components A and B are recycled back to the reactor. If one or more azeotropes are formed the distillation becomes more complex.

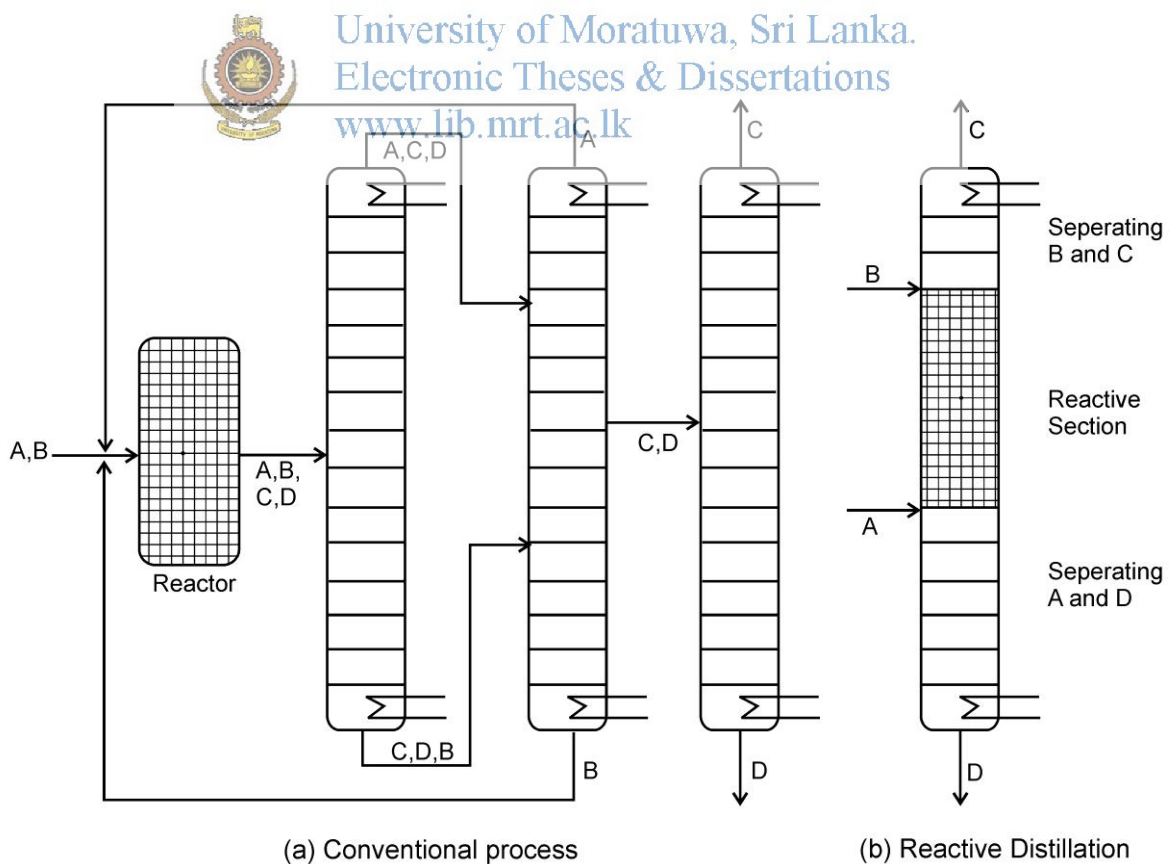

Figure 2.1: Comparison of reactive distillation with conventional Process

The reactive distillation column configuration shown in Figure 2.1(b) consists of a reactive section in the middle with nonreactive rectifying and stripping sections at the top and bottom respectively. Reactant B is recovered from the product C in the rectifying section. The task of stripping section is to strip off the reactant A from the product stream D. In the reactive section the products are separated from the reactants, driving the reaction equilibrium to the product side of the reaction. At the same time undesired side reactions between reactants and products are eliminated. According to literature a hundred percent conversion can be achieved by using properly designed reactive distillation columns (Taylor and Krishna, 2000).

In order to achieve good designs of reactive distillation units, various data and operational parameters are required. As the reactive distillation is a complex operation research work has been carried out to determine these data for various reactive distillation conditions by mathematical modeling as well as by experiments.

Lee and Dudukovic (1998) compared equilibrium and non equilibrium models for modeling reactive distillation. They have used the Homotopy-continuation method and Newton-Raphson method in solving model equations. Their results reveal that non-equilibrium model is preferred over equilibrium model because of the difficulty in the accurate prediction of tray efficiency in reactive distillation column. Synthesis of fatty acid esters of heavy alcohols for 2-ethyl hexyl dodecanoate using reactive distillation had been studied by Omata, Dimian, and Blik (2003). In this modeling research work experimental kinetic data for a super acidic sulphated zirconia catalyst have been employed. The results show that this catalyst is highly selective even for high alcohol to acid ratios.

An algorithm had been developed to model 2-pentene metathesis and MTBE synthesis by Steffen and Silva (2012). Their simulation results were close to the results available in other literature (Chen, Huss, Malone and Doherty, 2000; Singh, Kumar and Kaistha, 2005). A rigorous dynamic rate based model had been developed for the production of methyl acetate by Schneider, Noeres, Kreul and Gorak (1999). In their work thermodynamic non idealities have been considered for phase equilibrium and quasi homogeneous approach had been implemented which is also suitable for heterogeneous catalysis. Several experiments had been carried out in a pilot plant column to validate this model.

Maiti, Jana, and Samantha (2013) have developed a mathematical model for thermally integrated batch reactive distillation in which rectification tower runs at atmospheric pressure and the concentric reboiler runs at vacuum. Positive savings of energy and better economic figures have been inspected than that in the conventional batch reactive distillation. Edreder, Mujtaba, and Emtir (2011) have studied optimal operations of conventional and inverted batch reactive distillation for hydrolysis of methyl lactate to lactic acid. Minimum operation time is obtained by optimizing the reflux ratio.

Araromi, Sonibare, Justice and Afolobi (2011) have done an experimental study to recover acetic acid from an aqueous solution and production of a useful ester using reactive distillation. The homogeneously catalyzed esterification of dimethyl carbonate with ethanol has been modeled and compared with pilot scale experimental data by Keller and Gorak (2013). Lai, Liu, Yu, Lee and Hung (2008) have studied production of high purity ethyl acetate experimentally using a reactive distillation pilot-scale plant.

Kenig et al.,(2001) used a simulator called 'DESIGNER' which is completely rate based in order to predict concentrations, temperatures and other important process variables for reactive distillation. A set of reactive distillation experiments have been performed in a glass tray column with 80 bubble cap trays to validate their predictions. Harmsen (2007) has discussed commercial scale application areas, advantages, scale up and design methods and roles of various partners in the development and implementation of reactive distillation. Chiang, Kuo, Yu and Wong (2009) have compared reactor and column reactive distillation configurations for amyl acetate process.

2.2 Benefits of Reactive Distillation

Higher conversions are obtained for equilibrium-limited reactions due to shifting of the equilibrium to the right side of the reaction . Since products are continuously separated product concentration in the mixture reduces. Therefore the reversible reaction equilibrium goes to the product side (Bhatia et al., 2007). This is exemplified by the production of methyl acetate, methyl-tert butyl ether(MTBE), tert-amyl ether and production of condensation polymers. In some applications, chemical reaction has the beneficial effect of "reacting away" some of the azeotropes in the mixture and greatly simplifying the phase equilibrium behavior. This happens in the process for synthesis of MTBE. Improved selectivity is obtained because of removal of products from the

reaction zone and prevention from undergoing further reaction to by-products (Taylor et al., 2000).

Such benefits are obtained for example in the production of propylene oxide from propylene chlorohydrins, in the alkylation of benzene to produce cumene and in alkylation of butane to produce isooctane. Benefits of heat integration are obtained because the heat generated in the chemical reactions is used for vaporization (Taylor et al., 2000). This is particularly advantageous for situations involving high heats of reaction such as the hydration of ethylene oxide to ethylene glycol. Hot spot formation is therefore prevented.

2.3 Commercial Applications

There are many documented success stories involving the industrial implementation of reactive distillation. The applications of reactive distillation in the chemical and petroleum industries have increased rapidly in the past decade. One such example is the manufacturing of methyl acetate by the Eastman Chemical Company (Kumar., 2010). In this case a single reactive distillation column replaced eleven major unit operations along with heat exchangers, pumps, and controllers (Figure 2.2). The result was a five-fold reduction in capital investment and energy consumption over the conventional design for methyl acetate production (Kumar., 2010).

The concept of reactive distillation has been industrially applied for certain types of reactions. The most important being esterifications, transesterifications and etherifications in which the maximum reactant conversion is limited by chemical equilibrium. Nitrations, polycondensations, alkylation, halogenations, acetylation, aldol condensation, alkylation, amination, dehydration, hydrolysis, isomerization, and oligomerization are the other industrially applied chemical reactions (Hiwale et al., 2004). Nowadays, the reactive distillation application is observed with the largest number in installations producing methyl tertiary butyl ether (MTBE) which is used in gasoline blending. Other esters such as ethyl tertiary butyl ether (ETBE), tertiary-amyl methyl ether (TAME) or fatty acid methyl esters (FAME), are also produced by reactive distillation.

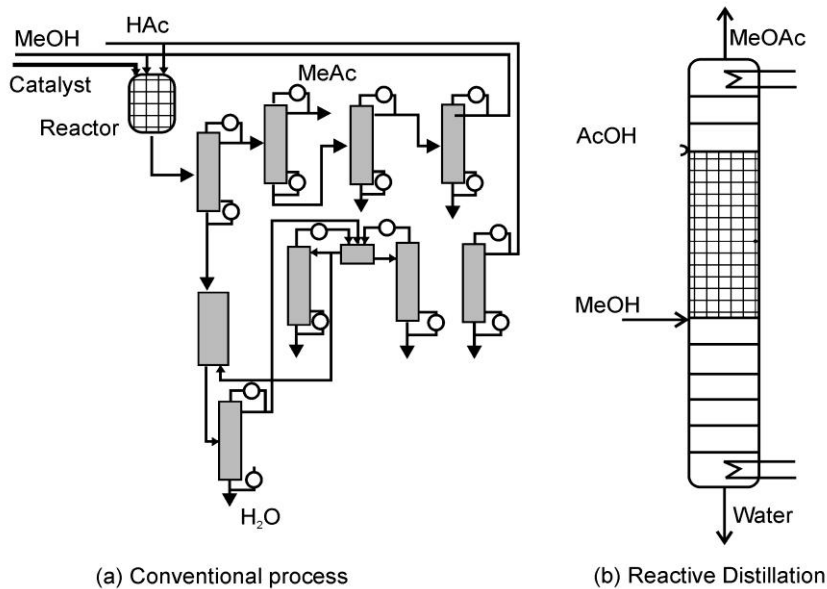

Figure 2.2: Processing schemes for Methyl acetate esterification reaction

(Source: Taylor and Krishna, 2000)

Conventional processing scheme consisting of one reactor followed by nine distillation columns is shown in figure 2.2(a).



University of Moratuwa, Sri Lanka.
Electronic Theses & Dissertations
www.lib.mrt.ac.lk

2.4 Application of Reactive Distillation in Esterification

Production of methyl acetate and MTBE are examples of successful commercial application of reactive distillation. Esterification reactions n-butanol, isobutyl alcohol, amyl alcohol and hexanol with acetic acid are common reactive systems which use reactive distillation (Hiwale et al., 2004). These alcohols are sparingly soluble in water and the ester is almost insoluble.

Butyl acetate is an important chemical which is used as a versatile solvent in various applications. It is commonly synthesized by esterification of n-butanol with acetic acid in the presence of acid catalyst. Homogenous catalyst is being used in this reaction. Difficulty in separation of catalyst from product stream, corrosion and disposal problems are likely to occur in homogenous catalyzed processes (Hiwale et al., 2004).

Amyl acetate is another important solvent ester that may be synthesized using reactive distillation. It is four times more efficient to use reactive distillation than reactor followed by distillation column in terms of the total annual cost (Hiwale et al., 2004). Methyl isopropyl

acetate is an important solvent and component in paints and adhesives due to its unique ability to dissolve both polar and non-polar compounds. The reaction is carried out in a reactive distillation column with acetic acid and 2-methyl propanol in the presence of ion exchange resins (Hiwale et al., 2004).

Methyl acetate is used as an intermediate in the manufacture of a variety of polyesters such as photographic film base, cellulose acetate, tenite cellulosic plastics and estron acetate. Sharma and Mahajani (2003) have discussed the manufacture of methyl acetate via reactive distillation.

2.5 Reactive Distillation Mathematical Models

For modeling reactive distillation columns, two distinctly different approaches are available in the literature (Taylor and Krishna, 2000)

(1) The equilibrium (EQ) stage model, in which the vapor and liquid phases are assumed to be in thermodynamic equilibrium, and

(2) The Non equilibrium (NEQ) stage model in which finite mass transfer rates across the vapor liquid interface is assumed



University of Moratuwa, Sri Lanka.
Electronic Theses & Dissertations
www.lib.mrt.ac.lk

Assumptions used in most reactive distillation model development are as follows (Estrada-Villagrana and Bogle, 1999).

1. Each separation stage in distillation is perfectly mixed. That is liquid composition at each stage is homogeneous and equal to the composition of liquid leaving the stage.
2. Entrainment of liquid drops in vapor and occlusion of vapor bubbles in liquid are negligible.
3. Vapor molar holdup and vapor-phase chemical reactions are neglected.

2.5.1 Equilibrium stage modeling of reactive distillation

The principal assumption of the equilibrium stage model is that the vapor and the liquid stream that leave the stage are in thermodynamic equilibrium. In most real distillation columns, the residence time is too short to reach total equilibrium. For this reason, Murphree efficiency and Vaporization efficiency have been introduced into the model to account for the non ideal behavior. The MESH equations which consists of material balance (M), equilibrium relationship (E), summation of all substances (S), and enthalpy balance (H) equations are used to model and simulate conventional distillation columns as well as reactive distillation(Taylor and Krishna,2000).

In order to write MESH equations for an equilibrium stage Taylor and Krishna (2000) have used the following figure 2.3.

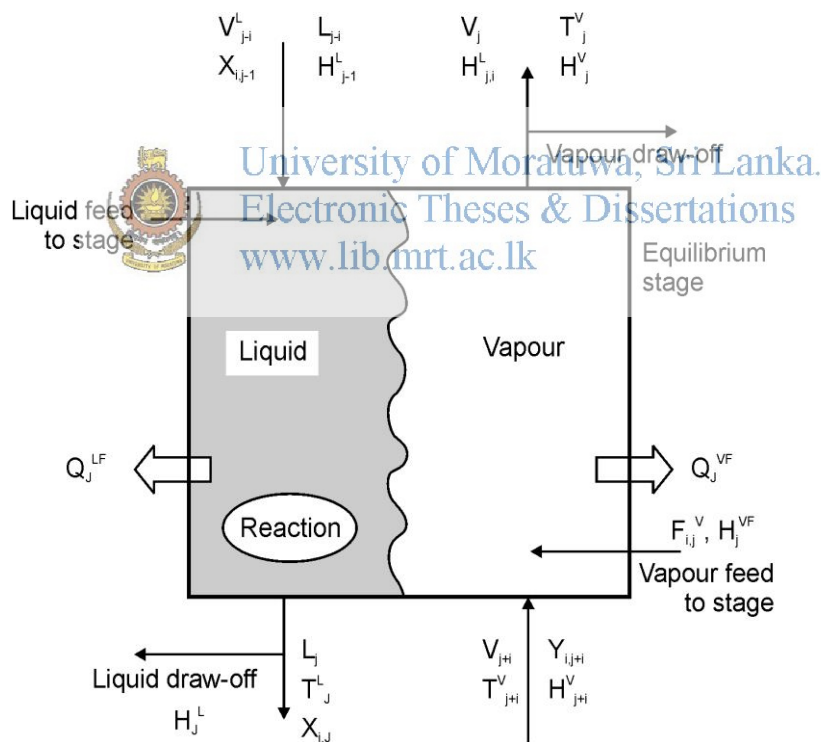

Figure 2.3: Equilibrium (EQ) stage in a reactive distillation column

(Source: Taylor and Krishna, 2000)

The figure 2.3 shows a schematic diagram of an equilibrium stage or a cross section of a reactive distillation column. In the model of Taylor and Krishna (2000) it is assumed that vapor and liquid phases are at equilibrium in the stage and reaction takes place at liquid

phase. Vapor from the stage below and liquid from the stage above are brought into contact on this stage together with any fresh or recycle feeds. The vapor and liquid streams leaving the stage are assumed to be in equilibrium with each other.

The equations that model equilibrium stages are known as the MESH equations, MESH being an acronym referring to the different types of equation as described in the above paragraph. The M equations are the material balance equations and the total material balance for an equilibrium stage of a reactive distillation as shown in figure 2.3 takes the form as shown in equation 2.5.1.1.

$$\frac{dU_j}{dt} = V_{j+1} + L_{j-1} + F_j - (1 + r_j^v)V_j - (1 + r_j^L)L_j + \sum_{m=1}^r \sum_{i=1}^c v_{i,m} R_{m,j} \varepsilon_j \dots \dots (2.5.1.1)$$

This type of modeling has been used in research works of Estrada, David and Bogle (1999) in their work on exploring the interaction between flows and composition in reactive distillation.

The notation U_j is the holdup on stage j . With very few exceptions, U_j is considered to be the hold-up only of the liquid phase. It is more important to include the hold-up of the vapor phase at higher pressures as it has high molar content.

The component material balance (neglecting the vapor hold-up) is as shown in equation 2.5.1.2.

$$\frac{dU_j x_{i,j}}{dt} = V_{j+1} y_{i,j+1} + L_{j-1} x_{i,j-1} + F_j z_{i,j} - (1 + r_j^v) V_j y_{i,j} - (1 + r_j^L) L_j x_{i,j} + \sum_{m=1}^r v_{i,m} R_{m,j} \varepsilon_j \dots \dots (2.5.1.2)$$

In the material balance equations 2.5.1.1 and 2.5.1.2 given above, r_j is the ratio of side stream flow into inter stage flow:

$$r_j^v = S_j^v / V_j \dots \dots (2.5.1.3)$$

$$r_j^L = S_j^L / L_j \dots \dots (2.5.1.4)$$

In these equations S is the inter stage flow that is the flow within a stage.

$v_{i,m}$ represents the stoichiometric coefficient of component i in reaction m and ε_j represents the reaction volume.

The phase equilibrium relations are shown in equation 2.5.1.5.

$$y_{i,j} = K_{i,j} x_{i,j} \dots \dots (2.5.1.5)$$

Chemical reaction equilibrium is not considered in many of the early models developed such as the models proposed by Holland(1963,1981), Henley & Seader (1981), Seader & Henley (1998) because it is more difficult to model.

The S equations in MESH are the summation equations shown in equation 2.5.1.6 and 2.5.1.7.

$$\sum_{i=1}^c x_{i,j} = 1 \dots \dots (2.5.1.6), \quad \sum_{m=1}^r y_{i,j} = 1 \dots \dots (2.5.1.7)$$

The enthalpy balance is given by equation 2.5.1.8.

$$\frac{dU_j H_j}{dt} = V_{j+1} H_{j+1}^V - V_j H_j^V + H_{j+1}^L - H_j^L - Q_j \dots \dots (2.5.1.8)$$



University of Moratuwa, Sri Lanka.
 Electronic Theses & Dissertations
www.lib.mrt.ac.lk

Equilibrium stage modeling needs accurate predictions of tray efficiency (Lee and Dudukovic, 1998).

2.5.2 Non equilibrium stage modeling of reactive distillation

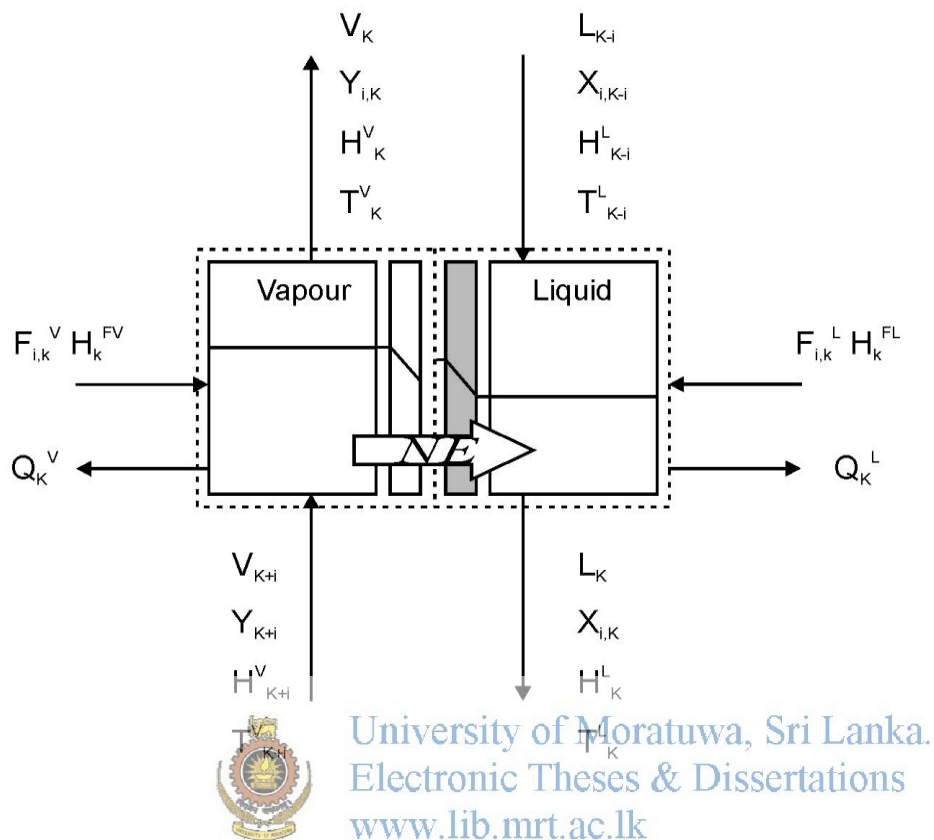

Figure 2.4: Non Equilibrium (NEQ) stage in a reactive distillation column

(Source: Taylor and Krishna, 2000)

A schematic representation of the NEQ stage is shown in above figure 2.4.A similar model has been used by Taylor and Krishna (2000) in their work. This NEQ stage may represent a tray or a cross section of a packed column. According to Taylor and Krishna (2000) the component molar balances for the vapor and liquid- phases are as shown in equation 2.5.2.1 and equation 2.5.2.2.

$$V_j y_{i,j} - V_{j+1} y_{i,j+1} - f_{i,j}^V + N_{i,j}^V = 0 \dots \dots (2.5.2.1)$$

$$L_j x_{i,j} - L_{j-1} x_{i,j-1} - f_{i,j}^L - N_{i,j}^L = 0 \dots \dots (2.5.2.2)$$

(Taylor and Krishna, 2000)

The total number of components in the mixture is taken as 'c' in the column tray or packed column cross section.

Here $N_{i,j}$ is the interfacial mass transfer rate and is the product of the molar flux and the net interfacial area. The overall molar balances are obtained by summing above two equations 2.5.2.1 and 2.5.2.2 over the total number of components in the mixture (c).

The most fundamentally sound way to model mass transfer in multi component systems is to use the Maxwell Stefan theory (Krishna & Weaseling, 1997; Taylor & Krishna, 1993). The Maxwell Stefan equations for mass transfer in the vapor and liquid-phases respectively are given by equation 2.5.2.3 and equation 2.5.2.4.

$$\frac{x_i}{RT^L} \frac{\partial \mu_i^L}{\partial z} = \sum_{k=1}^c \frac{x_i N_k^L - x_k N_i^L}{c_t^L \mathcal{D}_{i,k}^L} \dots \dots (2.5.2.3)$$

$$\frac{y_i}{RT^V} \frac{\partial \mu_i^V}{\partial z} = \sum_{k=1}^c \frac{x_i N_k^V - y_k N_i^V}{c_t^V \mathcal{D}_{i,k}^V} \dots \dots (2.5.2.4)$$

In these equations x_i and y_i are the mole fractions of species i in the liquid and vapor phases, respectively. The $\mathcal{D}_{i,k}$ represents the corresponding Maxwell Stefan diffusivity of the i - k pair (arbitrary two components from the four components) in the appropriate phase (vapor phase or liquid phase). Here only (c-1) numbers of equations are independent. The mole fraction of the last component is obtained by the summation equations for both phases.

The applications of NEQ model can be found in Krishna & Wesselingh (1997) and in Taylor & Krishna (1993).

At the vapor-liquid interface we can write the continuity equations as shown in equation 2.5.2.5.

$$N_i^V \Big|_I = N_i^L \Big|_I \dots \dots (2.5.2.5)$$

The $N_{i,j}$ is obtained from the Maxwell -Stefan equation as following equation 2.5.2.6:

$$\frac{x_{i,j}}{RT_j} \frac{\partial \mu_{i,j}^L}{\partial \eta} = \sum_{k=1}^c \frac{x_{i,j} N_{k,j}^L - x_{k,j} N_{i,j}^L}{c_{t,j}^L (\mathcal{K}_{i,k}^L \alpha)_j} \dots \dots (2.5.2.6)$$

Similar relation can be obtained for the vapor phase.

The $\mathcal{K}_{i,k}^L$ represents the mass transfer coefficient of the i - k pair (arbitrary two components i and k from four components) in the liquid- phase. This coefficient can be

estimated from information on the corresponding Maxwell -Stefan diffusivity $\mathcal{D}_{i,k}$ using the standard procedures discussed in Taylor and Krishna (1993). The notation ‘a’ is the interfacial area. In this case only (c-1) numbers of equations above are independent. The mole fraction of the last component is obtained by the summation equations for both phases.

The enthalpy balances for vapor and liquid-phases are given by equation 2.5.2.7 and equation 2.5.2.8 respectively.

$$V_j H_j^V - V_{j+1} H_{j+1}^V - F_j^V H_j^{VF} + \mathbb{E}_j^V + Q_j^V = 0 \dots \dots (2.5.2.7)$$

$$L_j H_j^L - L_{j-1} H_{j-1}^L - F_j^L H_j^{LF} - \mathbb{E}_j^L + Q_j^L = 0 \dots \dots (2.5.2.8)$$

The inter phase energy transfer rates E_j which is equal in both phases have conductive and convective contributions as shown in equation 2.5.2.9.

$$\mathbb{E}_j^L = -h_j^L a \frac{\partial T^L}{\partial \eta} + \sum_{i=1}^c N_{i,j}^L H_{i,j}^L \dots \dots (2.5.2.9)$$



University of Moratuwa, Sri Lanka.
Electronic Theses & Dissertations
www.lib.mrt.ac.lk

A similar relation can be written for the vapor phase as well. The h_j^L is the heat transfer coefficient in the liquid phase. The conductive contributions are ignored in some modeling studies.

At the vapor liquid interface phase equilibrium is assumed which is given by equation 2.5.2.10.

$$y_{i,j}|_I = K_{i,j} x_{i,j}|_I \dots \dots (2.5.2.10)$$

where the subscript i denotes the equilibrium compositions and $K_{i,j}$ is the vapor liquid equilibrium ratio for component i on stage j. The K values are evaluated at the temperature, pressure and composition of the interface from appropriate thermodynamic models (Taylor and Krishna,1993).

The non-equilibrium stage models predict more accurate results compared to EQ stage models as these models require accurate tray efficiency data (Lee and Dudukovic, 1998).

CHAPTER 3

DEVELOPMENT OF REACTIVE DISTILLATION MODEL

Reactive distillation allows combining the benefits of reactor where the reaction takes place and the distillation column where the separation takes place. Predictive process design requires a combination of mass transfer, heat transfer and reaction kinetics in reactive distillation.

3.1 Model Apparatus

In this work a single stage batch distillation process is used in developing the reactive distillation model equations. Although modeling works for multiple stage batch reactive distillation are available in literature (Patel et al, 2007) modeling of single stage batch distillation are lacking. The reactive batch distillation process used in this work is shown in figure 3.1.

It is assumed that the batch distillation column contains A_1 molar holdup constituting x mole fraction of the i -th species or component. Reactor is heated with a heating element and this has a heat duty Q_1 (J/min). The vapor V_1 leaving the distillation column has y vapor composition. Vapor enters a condenser which has a heat duty Q_0 (J/mol) and it produces a reflux stream (L_0) and a distillate stream (D).

Assumptions made in arriving at the modeling equations are as follows:

- Chemical reactions occur only in the liquid phase.
- Vapor phase is assumed to be ideal gas.
- Concentration through the liquid phase is homogeneous
- Heat generated due to chemical reaction is taken into account.
- Constant operating pressure.
- Entrainment is negligible.
- liquid is in equilibrium with vapor composition

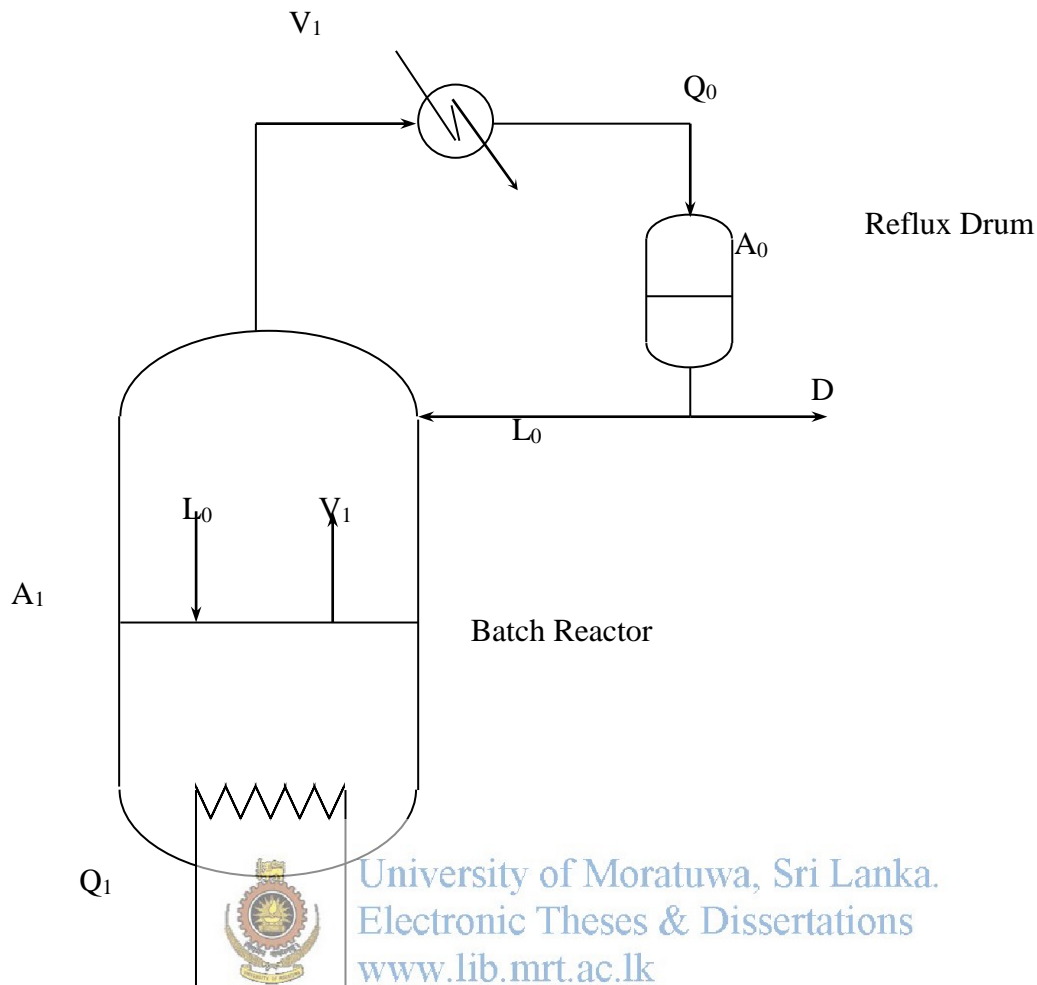

Figure 3.1: Single stage batch distillation process

3.2 Reaction Rate

The reaction rate for a reactant is considered as how fast a reaction takes place. Quantitatively, the reaction rate is expressed as the number of units of mass of some participant that is formed or transformed per unit of time t per unit of volume v of the system.

Based on definition of reaction rate, the reaction rate of a substance i , r_i is given by,

$$r_i = \frac{1}{v} \frac{dN_i}{dt} = \frac{(\text{moles } i \text{ formed})}{(\text{volume of fluid}) \times (\text{time})} \dots \dots (3.2.1)$$

$$\frac{dN_i}{dt} = r_i v \dots \dots (3.2.2)$$

dN/dt is moles i formed per unit time. In equation 3.2.1, v is the volume of the fluid. N_i is the number of moles of substance i formed. Considering that A is the molar holdup and C_i is the concentration of i^{th} component, the volume of the holdup mixture can be obtained by $\frac{A}{\sum c_i}$.

Therefore,

$$\frac{dN_i}{dt} = \frac{r_i A}{\sum c_i} \dots \dots (3.2.3)$$

R_i is defined as rate of reaction of the i^{th} component (r_i) divided by the summation of component concentrations. Therefore R_i can be written as follows.

$$R_i = \frac{r_i}{\sum c_i}$$

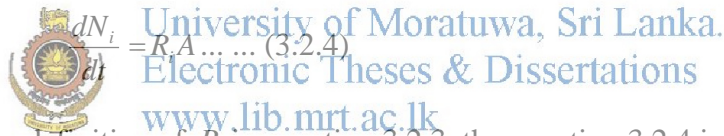

$$\frac{dN_i}{dt} = R_i A \dots \dots (3.2.4)$$

By substituting the definition of R_i in equation 3.2.3, the equation 3.2.4 is obtained.

The similar definition has been used by Patel et al. (2007) in their work on dynamic simulation of reactive batch distillation column for ethyl acetate synthesis. Therefore the rate of formation of reactants from the chemical reaction can be shown as follows.

$$\text{Rate of reactant formed due to chemical reaction} = \sum_{i=1}^c \frac{dN_i}{dt}$$

Derivation of basic mathematical model consists of mass and energy balances around condenser reflux drum and for a stage or plate.

Material balance for a reactant can be written as follows.

$$\left(\begin{array}{c} \text{rate of} \\ \text{reactant} \\ \text{flow into} \\ \text{element of} \\ \text{volume} \end{array} \right) = \left(\begin{array}{c} \text{rate of} \\ \text{reactant} \\ \text{flow out of} \\ \text{element of} \\ \text{volume} \end{array} \right) + \left(\begin{array}{c} \text{rate of} \\ \text{reactant loss} \\ \text{due to} \\ \text{chemical} \\ \text{reaction} \\ \text{within the} \\ \text{element of} \\ \text{volume} \end{array} \right) + \left(\begin{array}{c} \text{rate of} \\ \text{accumulation} \\ \text{of} \\ \text{reactant in} \\ \text{element of} \\ \text{volume} \end{array} \right) \quad \dots 3.2.5$$

3.3 Development of model equations for Condenser Reflux Drum

(a) Total Mole Balance

Considering equation 3.2.5 by applying total mole balance on the Condenser Reflux drum.



$$V_1 = L_0 + D - \sum_{i=1}^c \frac{dN_{0,i}}{dt} + \frac{dA_0}{dt} \dots \dots (3.3.1)$$

University of Moratuwa Sri Lanka
Electronic Theses & Dissertations
www.lib.mrt.ac.lk

Applying equation 3.2.4 for all components in the condenser reflux drum results in the following equation 3.3.2.

$$\sum_{i=1}^c \frac{dN_{0,i}}{dt} = A_0 \sum_{i=1}^c R_{0,i} \dots \dots (3.3.2)$$

By applying 3.3.2 in equation 3.3.1.

$$V_1 = L_0 + D - A_0 \sum_{i=1}^c R_{0,i} + \frac{dA_0}{dt} \dots \dots (3.3.3)$$

$$\frac{dA_0}{dt} = V_1 - L_0 - D + A_0 \sum_{i=1}^c R_{0,i} \dots \dots (3.3.4)$$

(b) Component wise Mole Balance for Condenser-Reflux Drum

Applying component molar balance equation 3.2.4 what is this equation for a component i in the condenser reflux drum, the following equation 3.3.5 can be obtained. The rate of component i flown into the system is given by $V_1 y_i$. The $Dx_{0,i}$ and $L_0 x_{0,i}$ are the rate of component i flown out of the system. Rate of component i lost due to chemical reaction in the condenser-reflux drum is given by $\frac{dN_{0,i}}{dt}$. Rate of accumulation of component i in the Condenser- reflux drum is $\frac{dA_0 x_{0,i}}{dt}$.

$$V_1 y_i = (D + L_0) x_{0,i} - \frac{dN_{0,i}}{dt} + \frac{dA_0 x_{0,i}}{dt} \dots \dots (3.3.5)$$

Substituting equation 3.2.4 in equation 3.3.5 gives equation (3.3.6),

$$V_1 y_i = (D + L_0) x_{0,i} - R_{0,i} A_0 + A_0 \frac{dx_{0,i}}{dt} + x_{0,i} \frac{dA_0}{dt} \dots \dots (3.3.6)$$



University of Moratuwa, Sri Lanka.
Electronic Theses & Dissertations
www.lib.mrt.ac.lk

From equation

$$(3.3.4) \quad V_1 y_i = (D + L_0) x_{0,i} - R_{0,i} A_0 + A_0 \frac{dx_{0,i}}{dt} + x_{0,i} \left(V_1 - L_0 - D + A_0 \sum_{i=1}^c R_{0,i} \right) \dots \dots (3.3.7)$$

$$V_1 y_i = - R_{0,i} A_0 + A_0 \frac{dx_{0,i}}{dt} + x_{0,i} A_0 \sum_{i=1}^c R_{0,i} + x_{0,i} V_1 \dots \dots (3.3.8)$$

$$\frac{dx_{0,i}}{dt} = \frac{V_1}{A_0} (y_{1,i} - x_{0,i}) + R_{0,i} - x_{0,i} \sum_{i=1}^c R_{0,i} \dots \dots (3.3.9)$$

(c) Overall Enthalpy Balance for Condenser Reflux Drum

Consider the rate of heat flow out of the condenser reflux drum system as, Q_0 . The rate of disappearance of heat by reaction within the condenser reflux drum is shown in equation 3.3.10.

$$-\Delta H_r \frac{dN_i}{dt} = -A_0 R_{0,i} \Delta H_r \dots \dots (3.3.10)$$

The rate of accumulation of heat within element of volume is given by equation 3.3.11.

$$\frac{d(A_0 H_{L,0})}{dt} = A_0 \frac{dH_{L,0}}{dt} + H_{L,0} \frac{dA_0}{dt} \dots \dots (3.3.11)$$

$H_{L,0} A_0$ is the enthalpy of the liquid in the condenser reflux drum.

Rate of heat flow into the condenser reflux drum is equal to the summation of rate of heat flow out of the condenser reflux drum, rate of disappearance of heat by reaction within the condenser reflux drum and rate of accumulation of heat within the condenser reflux drum. This heat balance is shown in equation 3.3.11.

$$H_{V,1} V_1 = H_{L,0} (L_0 + D) + (-A_0 R_0 \Delta H_r) + Q_0 + A_0 \frac{dH_{L,0}}{dt} + H_{L,0} \frac{dA_0}{dt} \dots \dots (3.3.12)$$

$H_{V,1} V_1$ is rate of heat flow into the condenser reflux drum from the vapor flow. The rate of heat flow out from distillate and reflux streams are $H_{L,0} D$ and $H_{L,0} L_0$ respectively.



University of Moratuwa, Sri Lanka
Electronic Theses & Dissertations
www.lib.mrt.ac.lk

Substituting from equation (3.3.4)

$$H_{V,1} V_1 = H_{L,0} (L_0 + D) + (-A_0 R_0 \Delta H_r) + Q_0 + A_0 \frac{dH_{L,0}}{dt} + H_{L,0} (V_1 - L_0 - D) + A_0 \sum_{i=1}^c R_{0,i}$$

... .. (3.3.13)

Rearranging equation 3.3.12

$$\frac{dH_{L,0}}{dt} = \frac{V_1}{A_0} (H_{V,1} - H_{L,0}) + R_0 \Delta H_r - \frac{Q_0}{A_0} - H_{L,0} \sum_{i=1}^c R_{0,i} \dots \dots \dots (3.3.14)$$

3.4 Development of model equations for the Reactor Batch

(a) Total Mole Balance for Reactor Batch

Rate of total mole flow into the reactor batch is equal to the sum of rate of mole flow out of the reactor batch, rate of mole lost due to chemical reaction within the reactor batch and rate of accumulation of total moles in the reactor batch. This relationship can be expressed as an equation as shown in equation 3.4.1.

$$L_0 = V_1 - \sum_{i=1}^c \frac{dN_{1,i}}{dt} + \frac{dA_1}{dt} \dots \dots (3.4.1)$$

By applying rate of component i lost from reaction which is given by $\frac{dN_{1,i}}{dt}$ as shown in equation 3.2.4, for all components 'c' in the reactor batch and summing them up results in the following equation 3.4.2.



University of Moratuwa, Sri Lanka.
 Electronic Theses & Dissertations
 For submission $\sum_{i=1}^c \frac{dN_{1,i}}{dt} - A_1 \sum_{i=1}^c R_{1,i}$ (3.4.2)
www.lib.mrt.ac.lk

$$\frac{dA_1}{dt} = L_0 - V_1 + A_1 \sum_{i=1}^c R_{1,i} \dots \dots \dots (3.4.3)$$

(b) Component wise Mole Balance for Reactor Batch

In the component wise mole balance for batch reactor, the addition of rate of component flow out of the reactor batch, rate of component lost due to chemical reaction within the reactor batch and rate of accumulation of component in the reactor batch is equated to rate of component flow into the reactor batch. This is shown in equation 3.4.4.

The rate of component i flow into the reactor batch from reflux drum is $L_0 x_{0,i}$. Similarly $V_1 y_{1,i}$ is the rate of component i flow out of the reactor batch as vapor. Rate of component (i) lost from reaction is given by $\frac{dN_{1,i}}{dt}$. In equation 3.4.4

$\frac{dA_1 x_{1,i}}{dt}$ is the rate of accumulation of component i in the reactor batch.

$$L_0 x_{0,i} = V_1 y_{1,i} - \frac{dN_{1,i}}{dt} + \frac{dA_1 x_{1,i}}{dt} \dots \dots (3.4.4)$$

$$L_0 x_{0,i} = V_1 y_{1,i} - R_{1,i} A_1 + A_1 \frac{dx_{1,i}}{dt} + x_{1,i} \frac{dA_1}{dt} \dots \dots (3.4.5)$$

By applying equation (3.4.3) in equation (3.4.5)

$$L_0 x_{0,i} = V_1 y_{1,i} - R_{1,i} A_1 + A_1 \frac{dx_{1,i}}{dt} + x_{1,i} \left(L_0 - V_1 + A_1 \sum_{i=1}^c R_{1,i} \right) \dots \dots (3.4.6)$$

$$\frac{dx_{1,i}}{dt} = \frac{L_0}{A_1} (x_{0,i} - x_{1,i}) + \frac{V_1}{A_1} (x_{1,i} - y_{1,i}) + \left(R_{1,i} - x_{1,i} \sum_{i=1}^c R_{1,i} \right) \dots \dots (3.4.7)$$

(c) Overall Enthalpy Balance around Reactor Batch

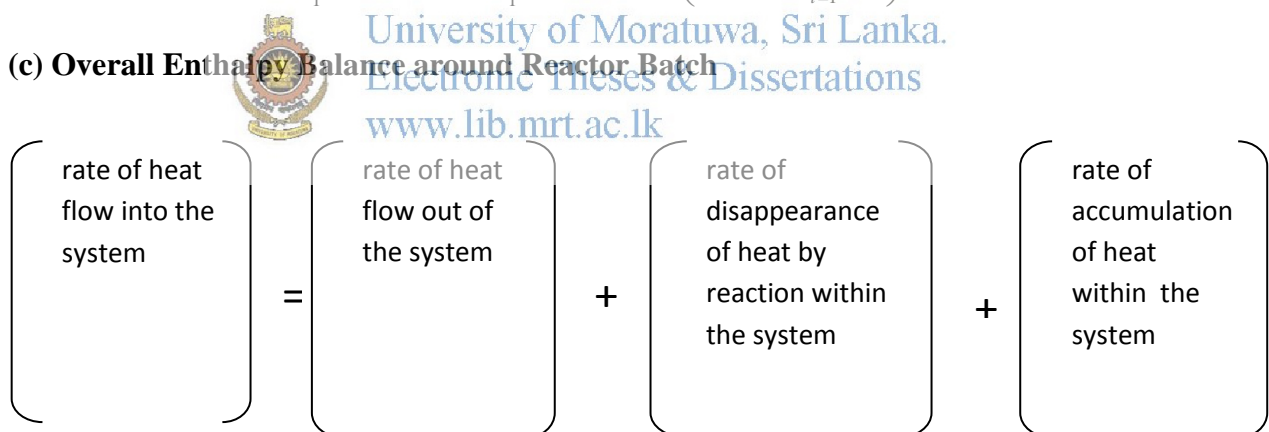

In order to apply the energy balance on reactor batch the rate of heat flow into the reactor batch from heater is taken as Q_1 .

The rate of disappearance of heat by reaction within the element of volume is given by the equation 3.4.8 as shown below.

$$= -\Delta H_r \frac{dN_i}{dt} = -A_1 R_{1,i} \Delta H_r \dots \dots (3.4.8)$$

The rate of accumulation of heat within element of volume is given by equation 3.4.9.

$$\frac{d(A_1 H_{L,1})}{dt} = A_1 \frac{dH_{L,1}}{dt} + H_{L,1} \frac{dA_1}{dt} \dots \dots (3.4.9)$$

The rate of heat flow into the reactor batch from the reflux stream is $H_{L,0} L_0$. Rate of heat flow out from the reactor batch is $H_{v,1} V_1$. This heat is associated with the vapor leaving the reactor batch.

Rate of heat flow into the reactor batch is equal to the summation of rate of heat flow out of the system, rate of disappearance of heat by reaction within the system and rate of accumulation of heat within the system. This relationship can be shown in equation 3.4.10

$$H_{L,0} L_0 = H_{v,1} V_1 + (-A_1 R_1 \Delta H_r) - Q_1 + A_1 \frac{dH_{L,1}}{dt} + H_{L,1} \frac{dA_1}{dt} \dots \dots (3.4.10)$$

Substitution of $\frac{dA_1}{dt}$ from equation (3.4.3) in equation 3.4.10 gives equation 3.4.11.

$$H_{L,0} L_0 = H_{v,1} V_1 + (-A_1 R_1 \Delta H_r) - Q_1 + A_1 \frac{dH_{L,1}}{dt} + H_{L,1} \left(L_0 - V_1 + A_1 \sum_{i=1}^c R_{1,i} \right) \dots (3.4.11)$$

By rearranging equation 3.4.11 gives,

$$\frac{dH_{L,1}}{dt} = \frac{Q_1}{A_1} - \frac{L_0}{A_1} (H_{L,1} - H_{L,0}) - \frac{V_1}{A_1} (H_{v,1} - H_{L,1}) + R_1 \Delta H_r - H_{L,1} \sum_{c=1}^c R_{1,i} \dots \dots (3.4.12)$$

3.5 Equilibrium Relationships

From Raoult's law

$$y_j P = x_j P_j^{sat} \dots \dots \dots (3.5.1) \text{ (Smith } et al., 1996)$$

In equation (3.5.1) P is pressure in the column and P^{sat} is saturation pressure of component i. The individual values of y_i and x_i should satisfy the equations 3.5.2 and 3.5.3 below. The summation of mole fractions of the components in the liquid and vapor phase should be equal to 1.

$$\sum_{i=1}^c x_i = 1 \dots \dots \dots (3.5.2)$$

$$\sum_{i=1}^c y_i = 1 \dots \dots \dots (3.5.3)$$

3.6 Enthalpy Relationships University of Moratuwa, Sri Lanka. Electronic Theses & Dissertations

The notations H^L and H^V give the enthalpy of liquid and vapor phase respectively and from the relationships shown in equations 3.6.1 and 3.6.2 each of these values can be estimated. The value of H^L depends on liquid phase mole fraction and temperature where as H^V is a function of vapor phase composition. The $c_{p,i}^L$ is the specific heat of component i in the liquid phase at temperature T. The h_i^L and $h_{fg,i}$ are heat capacity of component i in the liquid phase and latent heat of vaporization of component i respectively.

$$H^L = \sum_{i=1}^c x_i c_{p,i}^L T \dots \dots (3.6.1) \text{ (Patel } et al., 2007)$$

$$H^V = \sum_{i=1}^c y_i (h_i^L + h_{fg,i}) \dots \dots (3.6.2) \text{ (Patel } et al., 2007)$$

3.7 Equilibrium Data

The equilibrium relationship is obtained by modified Raoult's law which is valid for low to moderate pressure.

Modified Raoult's Law for low to moderate pressure is given by

$$y_i P = x_i \gamma_i P_i^{sat} \text{ (Smith et al., 1996)}$$

The vapor phase composition and temperature can be calculated by bubble point program (Smith et al., 1996).

3.8 Bubble Temperature Parameters

Ideal gas model for the vapor phase is given by equation 3.8.1.

$$y_i P = x_i \gamma_i P_i^{sat} \dots \dots (3.8.1)$$

The γ_i is the activity coefficient of component



University of Moratuwa, Sri Lanka.
Electronic Theses & Dissertations
www.lib.mrt.ac.lk

(i) Activity Coefficient

The activity coefficient is given by Wilson equation (Smith et al., 2001).

$$\ln \gamma_i = 1 - \ln \left(\sum_j x_j G_{ij} \right) - \sum_k \left(\frac{x_k G_{ki}}{\sum_j x_j G_{kj}} \right) \dots \dots (3.8.2)$$

(ii) Parameter G

The temperature dependence of the G_{ij} parameter is given by:

$$G_{ij} = \frac{V_j}{V_i} \exp \left(\frac{-a_{ij}}{RT} \right) \dots (i \neq j) \dots \dots (3.8.3)$$

Where V_j and V_i are the molar volumes of temperature T (K) of the pure liquids j and i respectively,

And a_{ij} is taken as a constant over temperature range 350K and 400K.

$$a_{ij} \neq a_{ji} \text{ and } G_{ij} \neq G_{ji}$$

The values of Wilson parameters a_{ij} used in above equation 3.12.3 for the chemical species can be obtained from literature (Simandl and Svrcek, 1991; Patel et al, 2007).

(iii) Molar Volume

$$V^{sat} = V_c Z_c \left(1 - \frac{T}{T_c}\right)^{0.2857} \dots (3.8.4)$$

The molar volume of saturated liquids is given by Rackett equation (Smith et al., 2001).

The V_c and T_c are critical volume and critical temperature of liquids respectively.



University of Moratuwa, Sri Lanka.
Electronic Theses & Dissertations
www.lib.mrt.ac.lk

3.9 Flow chart for Bubble Temperature Estimation

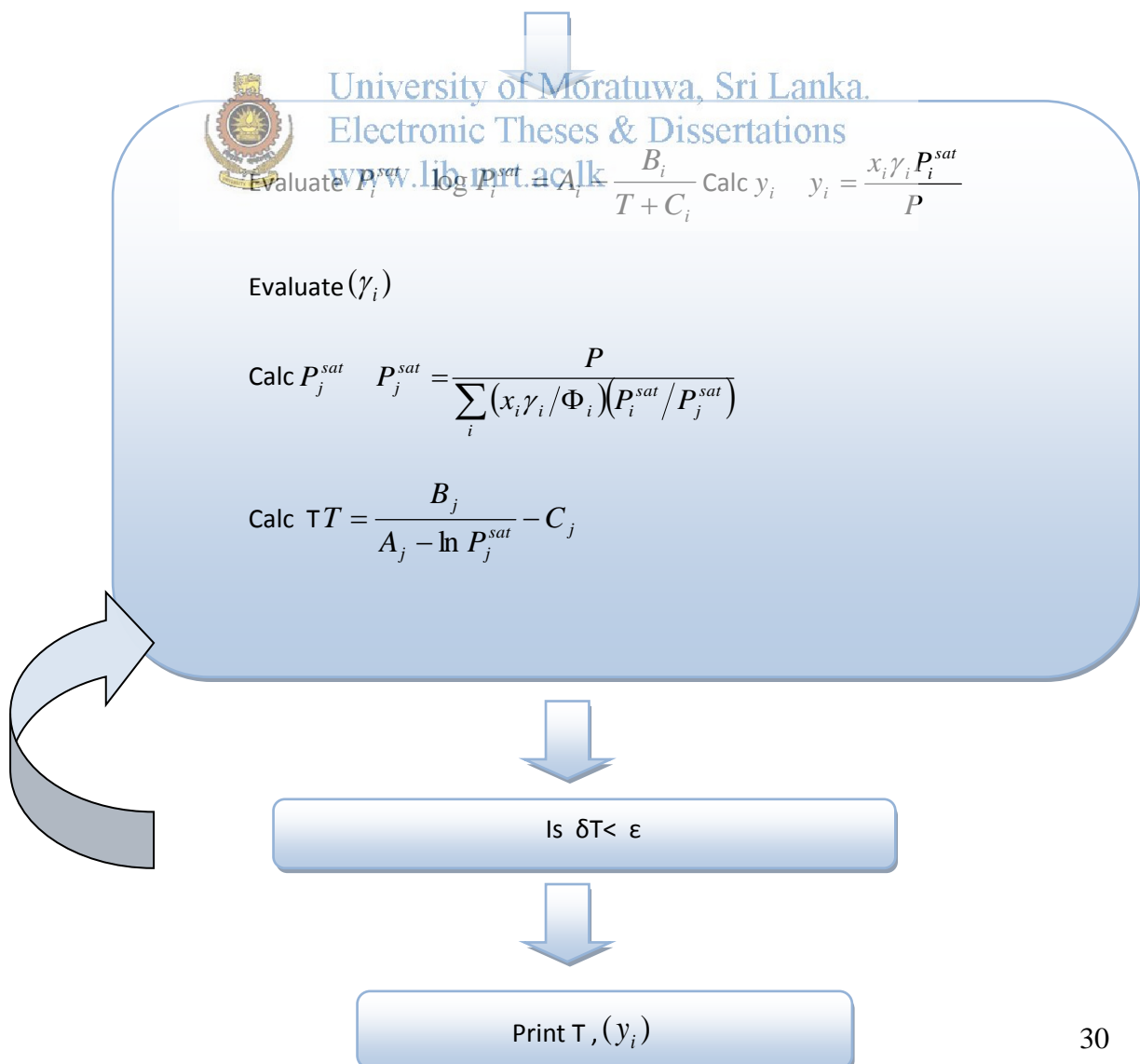
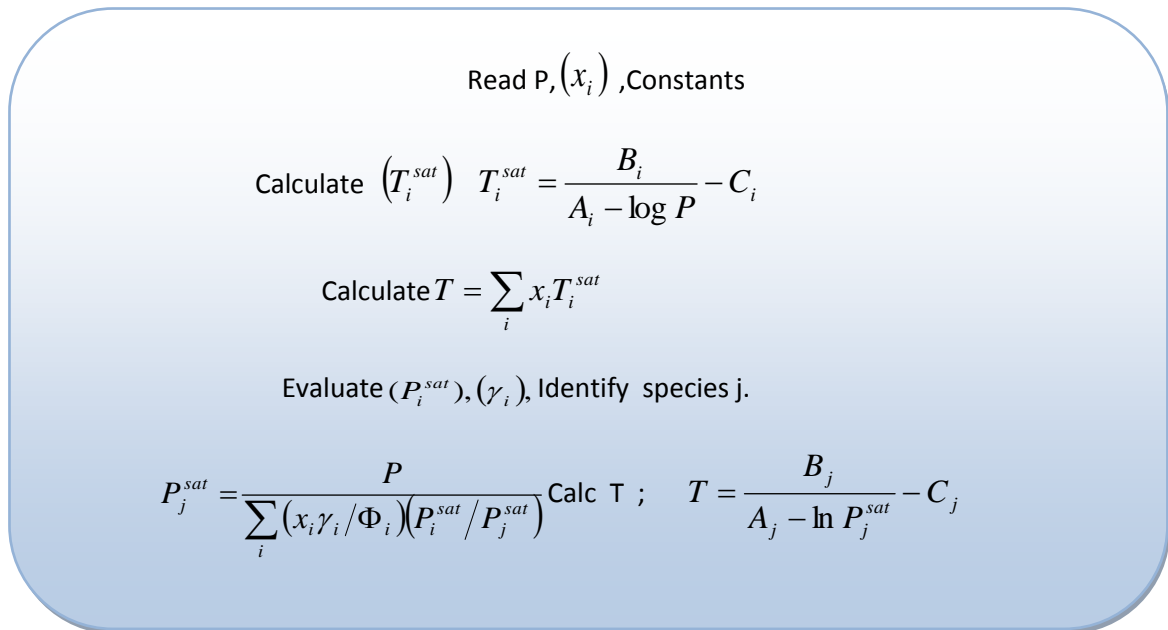

3.10 Flow chart for dynamic modeling of Reactive Batch Distillation (RBD) column

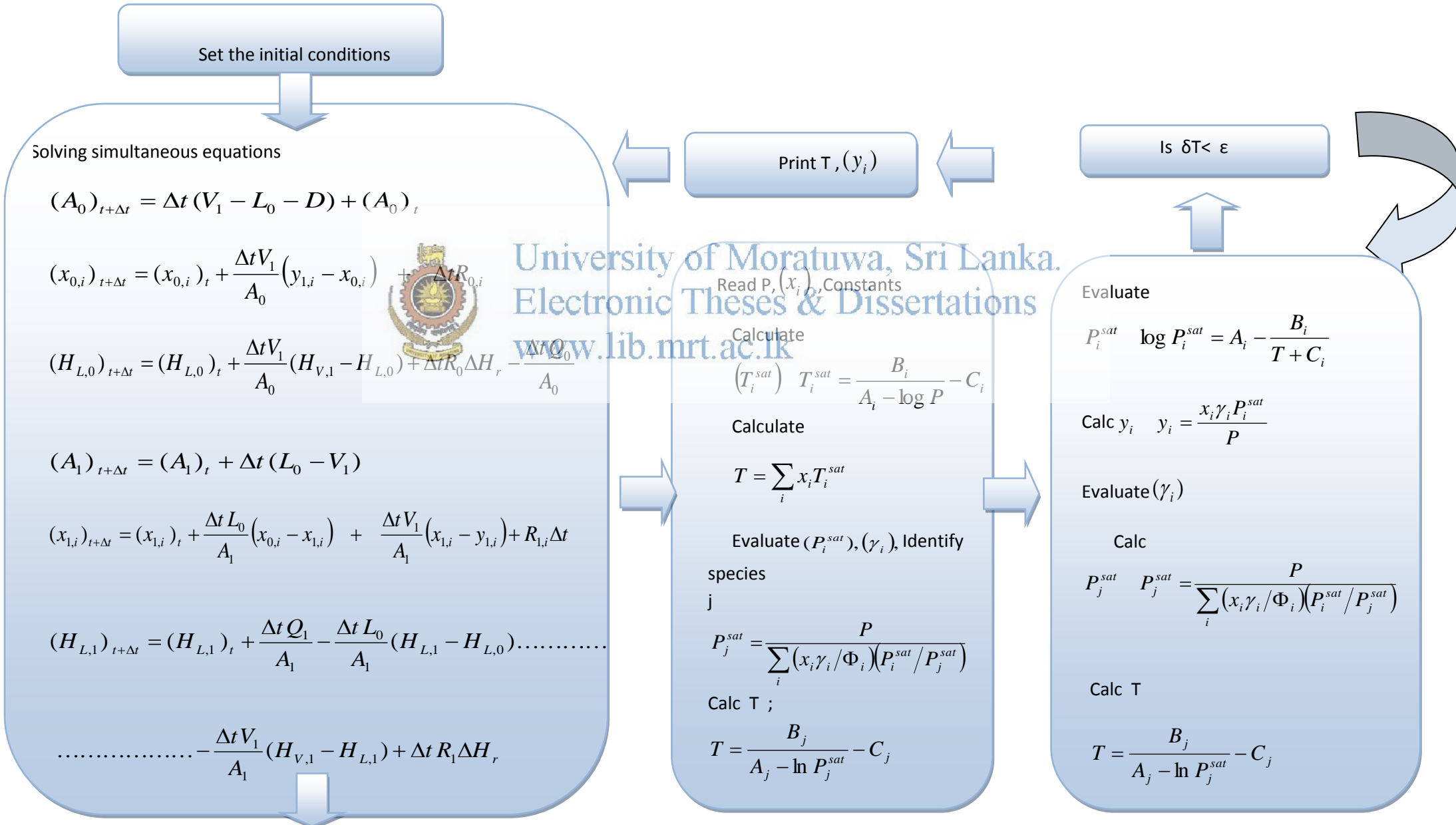

Chapter 4

MODELING ACETIC ACID ESTERIFICATION IN REACTIVE BATCH DISTILLATION

Ethyl acetate is used by many industries and it can be produced by esterification of acetic acid in the presence of catalysts such as sulphuric acid, parasulphonic acid or ion exchange resins. In this study the batch wise esterification of acetic acid with ethanol in a reactive distillation unit was modeled. The esterification reaction was analyzed for two cases. One case was for homogeneous kinetics with sulfuric acid catalyst and the other was for heterogeneous kinetics with an acidic cation exchange resin catalyst.

4.1 Reaction Kinetics

Acetic acid reacts with ethanol in the presence of a catalyst to give ethyl acetate and water. This is an exothermic reversible reaction as shown in equation 4.1.1.

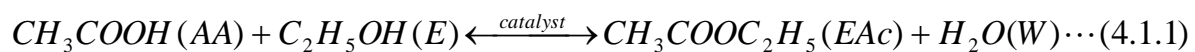

The catalyst used in this reaction could be a homogeneous or a heterogeneous catalyst.

4.1.1 Homogeneous Reaction Kinetics



University of Moratuwa, Sri Lanka.
Electronic Theses & Dissertations
www.lib.mrt.ac.lk

For a homogeneous reaction of esterification of acetic acid to produce ethyl acetate in the presence of a homogeneous catalyst such as sulphuric acid the reaction rate 'r' can be written as follows,

$$r = K_f C_{AA} C_E - K_r C_{EAc} C_w \dots (4.1.2)$$

In this equation C is the concentration of the reactant or product species.

When M is the molecular mass of 'i' species, x_i is the mole fraction of the i species and ρ is the density of the solution, the concentration can be expressed as,

$$C_i = \frac{x_i \rho}{\sum x_i M_i}$$

By substituting this expression in equation 4.1.2 equation 4.1.3 is derived.

$$r = \frac{\rho^2}{\left(\sum x_i M_i\right)^2} (K_f x_1 x_2 - K_r x_3 x_4) \dots \dots (4.1.3)$$

By applying equation 4.1.3 in equation 4.1.4 the following equation 4.1.5 is obtained.

$$R = \frac{r}{\sum c_i} \dots \dots \dots (4.1.4)$$

$$R = \frac{\rho \sum x_i}{\left(\sum x_i M_i\right)} (K_f x_1 x_2 - K_r x_3 x_4) \dots \dots \dots (4.1.5)$$

The heat of reaction shown in reaction equation 4.1.2 is,

$$\Delta H_r = -14.5 \text{ kJ/mol (Giessler et al., 2001).}$$

From literature the value of forward reaction rate constant in reaction equation 4.1.2 is,

$$K_f = 4.76 \times 10^{-4} \text{ litre/gmol.min (Mujtaba and Macchietto, 1997)}$$

The backward reaction rate constant in reaction equation 4.1.2 is,

$$K_r = 1.63 \times 10^{-4} \text{ litre/gmol.min (Mujtaba and Macchietto, 1997)}$$

4.1.2 Heterogeneous Reaction Kinetics

The esterification of acetic acid was modeled and simulation for the heterogeneous catalyst Trilite SCR-B which is an ion exchange resin mainly used in the water treatment industry. The acidic cationic form of this resin has been studied for the above reaction by De Silva et al (2014) and the most suitable heterogeneous model for this reaction had been identified as the Langmuir-Hinshelwood (LH) kinetic model.

The Langmuir-Hinshelwood (LH) kinetic model is given by equation 4.1.6.

$$r = \frac{k C_{Ac} C_E - \frac{C_{EA} C_w}{K_{eq}}}{\left(1 + k_w C_w + k_E C_E\right)} \dots \dots \dots (4.1.6)$$

According to De Silva et al (2014) study the constants k , k_w and k_E at 345K temperature have the values as follows,

$$k = 5.0 \times 10^{-4}$$

$$k_w = 3.2 \times 10^{-2}$$

$$k_E = 1.3 \times 10^{-1}$$

K_{eq} is the equilibrium constant and according the study of De Silva et al (2014) its value is,

$$K_{eq} = 1.907 \quad C_i = \frac{x_i \rho}{\sum x_i M_i}$$

By substituting this expression in equation 4.1.6 results in the following 4.1.7 equation

$$R = \frac{\rho^2 k (x_1 x_2 - (x_3 x_4 / 1.907))}{[(\sum x_i M_i)^2 + k_w x_3 \rho + k_E x_2 \rho]} \dots\dots\dots (4.1.7)$$

4.2 Reactive Distillation Design System



University of Moratuwa, Sri Lanka.

Electronic Theses & Dissertations

www.libr.mru.ac.lk

Consider the reactive distillation system shown in figure 3.1 with a single stage batch distillation column containing A_0 molar holdup along with a batch reactor with A_0 molar holdup. Batch distillation column contains x mole fraction of i^{th} component. In this reboiler heat duty is Q_1 (J/mol) and vapor V_1 leaving the distillation column has y vapor composition. Vapor enters the condenser having a heat duty Q_0 and it produces L_0 reflux and D distillate streams.

For the design batch it was assumed that 5000 total moles is fed into the reactor. Further it was assumed that 100 moles of the same solution is fed into the condenser reflux drum initially.

For the homogeneous kinetics study the initial composition of the feed to the reactor and the condenser reflux drum was assumed to be 0.45 acetic acid mole fraction, 0.45 ethanol mole fraction and 0.1 water mole fraction. For the heterogeneous reaction kinetics, two initial compositions were studied. One composition was the same as that for homogeneous study that was, an acetic acid mole fraction of 0.45, ethanol mole fraction of 0.45 and a water mole fraction of 0.1 and the other composition was 0.5 mole fraction of acetic acid and 0.5 mole fraction of ethanol.

4.3 Material and enthalpy balance model equations

A summary of the model equations for modeling esterification reaction of acetic acid in a batch reactive distillation column are given in equations 4.2.1 to 4.2.6.

These material and enthalpy balance equations were used in modeling ethyl acetate production process.

(i) Model equations for condenser reflux drum

$$\frac{dA_0}{dt} = V_1 - L_0 - D + A_0 \sum_{i=1}^c R_{0,i} \dots\dots\dots(3.3.4)$$

$$\frac{dx_{0,i}}{dt} = \frac{V_1}{A_0} (y_{1,i} - x_{0,i}) + R_{0,i} - x_{0,i} \sum_{i=1}^c R_{0,i} \dots\dots\dots(3.3.9)$$

$$\frac{dH_{L,0}}{dt} = \frac{V_1}{A_0} (H_{V,1} - H_{L,0}) + R_0 \Delta H_r - \frac{Q_0}{A_0} - H_{L,0} \sum_{i=1}^c R_{0,i} \dots\dots\dots(3.3.13)$$

(ii) Model equations for Reactor Batch



University of Moratuwa, Sri Lanka.
Electronic Theses & Dissertations
www.lib.mrt.ac.lk

$$\frac{dA_1}{dt} = L_0 - V_1 + A_1 \sum_{i=1}^c R_{1,i} \dots\dots\dots(3.4.3)$$

$$\frac{dx_{1,i}}{dt} = \frac{L_0}{A_1} (x_{0,i} - x_{1,i}) + \frac{V_1}{A_1} (x_{1,i} - y_{1,i}) + \left(R_{1,i} - x_{1,i} \sum_{i=1}^c R_{1,i} \right) \dots\dots\dots(3.4.7)$$

$$\frac{dH_{L,1}}{dt} = \frac{Q_1}{A_1} - \frac{L_0}{A_1} (H_{L,1} - H_{L,0}) - \frac{V_1}{A_1} (H_{V,1} - H_{L,1}) + R_1 \Delta H_r - H_{L,1} \sum_{c=1}^c R_{1,i} \dots\dots\dots(3.4.12)$$

4.4 Degrees of Freedom

The degree of freedom is the number of variables that must be specified in order to define the process completely. This can be found by subtracting number of independent equations from number of variables.

The following table 4.1 shows the number of independent equations.

Table 4.1: Number of independent equations

Equation Number	Number of independent equations
3.3.4	1
3.3.9	4
3.3.13	1
3.4.3	1
3.4.7	4
3.4.12	1
3.5.1	4
3.5.2	2
3.5.3	1

From the above table, total number of independent equations is 19.

The variables in modeling equations are as follows;

$$A_0 \quad x_{0,1} \quad x_{0,2} \quad x_{0,3} \quad x_{0,4} \quad H_{L,0} \quad V_1 \quad L_0 \quad D$$

$$A_1 \quad x_{1,1} \quad x_{1,2} \quad x_{1,3} \quad x_{1,4} \quad H_{L,1} \quad Q_0 \quad Q_1 \quad P$$

$$y_{1,1} \quad y_{1,2} \quad y_{1,3} \quad y_{1,4}$$

Table 4.2: The variables in modeling equations

A_0	Molar holdup in Condenser reflux drum	V_1	Vapor flow rate
$x_{0,1}$	Molar fraction of acetic acid in Condenser reflux drum	L_0	Liquid flow rate
$x_{0,2}$	Molar fraction of ethanol in Condenser reflux drum	D	Distillate flow rate
$x_{0,3}$	Molar fraction of water in Condenser reflux drum	A_1	Molar holdup in reactor
$x_{0,4}$	Molar fraction of ethyl acetate in Condenser reflux drum	Q_0	Heat duty on Condenser reflux drum
$x_{1,1}$	Molar fraction of acetic acid in reactor liquid phase	Q_1	Heat duty on reboiler
$x_{1,2}$	Molar fraction of ethanol in reactor liquid phase	P	Pressure in the system
$x_{1,3}$	Molar fraction of water in reactor liquid phase	$y_{1,1}$	Molar fraction of acetic acid in reactor vapor phase
$x_{1,4}$	Molar fraction of ethyl acetate in reactor liquid phase	$y_{1,2}$	Molar fraction of ethanol in reactor vapor phase
$H_{L,0}$	Liquid enthalpy in the Condenser reflux drum	$y_{1,3}$	Molar fraction of water in reactor vapor phase
$H_{L,1}$	Liquid enthalpy in the reactor	$y_{1,4}$	Molar fraction of ethyl acetate in reactor vapor phase



Electronic Theses & Dissertations
www.lib.mrt.ac.lk

Degree of freedom $F = \text{Total number of variables} - \text{Total number of independent equations}$

$$= 22 - 19 = 3$$

Therefore, three variables need to be specified in order to obtain feasible solutions. Thus following variables were specified as shown below.

1. Pressure $P = 1.013 \text{ bar}$
2. L_0/V_1 ratio
3. Vapor flow rate value = V_1 (moles/hr)

The (total) vapor flow rate, V_1 was considered as constant in this work and its value was taken as 90 moles per hour. This enabled the determination of L_0 for an assumed L_0/V_1 ratio. Since the molar hold up in the condenser reflux drum, A_0 was kept constant at 100 moles at all times, the value of D for an assumed L_0/V_1 ratio could be determined. This enabled the determination of the reflux ratio, $R = L_0/D$ for the particular simulation run.

Vapor-phase holdup was assumed to be negligible compared to liquid phase holdup and chemical reactions were assumed to occur only in the liquid phase. Pressure was assumed constant throughout the operation. Total condensation with no sub cooling was assumed in condenser. Heat generated due to chemical reaction was taken into account in enthalpy balance equations. Vapor phase was assumed to be an ideal gas.

4.5 Algebraic equations

In order to solve the model equations two total mole balance equations and eight component wise mole balance equations were converted into algebraic equations using Euler method.

By applying Euler method for differential equations 3.3.4, 3.3.9, 3.3.13, 3.4.3, 3.4.7, 3.4.12, equations 4.5.1 to 4.5.6 were obtained.

$$(A_0)_{t+\Delta t} = \Delta t (V_1 - L_0 - D) + (A_0)_t \quad \dots\dots\dots (4.5.1)$$

$$(x_{0,i})_{t+\Delta t} = (x_{0,i})_t + \frac{\Delta t V_1}{A_0} (y_{1,i} - x_{0,i}) + \Delta t R_{0,i} \quad \dots\dots\dots (4.5.2)$$

$$(H_{L,0})_{t+\Delta t} = (H_{L,0})_t + \frac{\Delta t V_1}{A_0} (H_{L,0} - H_{L,0}) + \frac{\Delta t Q_0}{A_0} \quad \dots\dots\dots (4.5.3)$$

$$(A_1)_{t+\Delta t} = (A_1)_t + \Delta t (L_0 - V_1) \quad \dots\dots\dots (4.5.4)$$

$$(x_{1,i})_{t+\Delta t} = (x_{1,i})_t + \frac{\Delta t L_0}{A_1} (x_{0,i} - x_{1,i}) + \frac{\Delta t V_1}{A_1} (x_{1,i} - y_{1,i}) + R_{1,i} \Delta t \quad \dots\dots\dots (4.5.5)$$

$$(H_{L,1})_{t+\Delta t} = (H_{L,1})_t + \frac{\Delta t Q_1}{A_1} - \frac{\Delta t L_0}{A_1} (H_{L,1} - H_{L,0}) - \frac{\Delta t V_1}{A_1} (H_{V,1} - H_{L,1}) + \Delta t R_1 \Delta H_r \quad \dots\dots\dots (4.5.6)$$

These twelve algebraic equations (4.5.1-4.5.6) were solved using computer software Matlab. Vapor composition that is in equilibrium with liquid composition and bubble point temperature were calculated simultaneously using bubble point program written using the Matlab software.

4.6 Bubble Temperature Calculation

Bubble temperature can be calculated using the steps in flow chart given in Figure 3.13. Example calculations of the parameters used for bubble point, calculation of the bubble point temperature and the first iteration of the bubble point are shown in Appendix A, Appendix B, Appendix C respectively.

It was assumed that initial acetic acid, ethanol, water and ethyl acetate mole fractions were 0.45, 0.45, and 0.1,0 respectively. Saturated temperatures for four components were calculated from Antoine equations. Next approximate temperature value was then calculated for those four temperatures. The saturated pressure values were calculated from Antoine equation for those approximate temperature determined.

The activity coefficients were calculated using Wilson equation (Smith *et al.*, 2001). For the esterification reaction of acetic acid with ethanol the Wilson parameters used in determination of activity coefficients were as follows.

$$a_{1,2} = -130.6527, a_{2,1} = 101.6588, a_{3,1} = 403.1564, a_{4,1} = -464.1529$$

$$a_{1,3} = 2.0311, a_{2,3} = 198.1757, a_{3,2} = 466.1059, a_{4,2} = 28.8790$$

$$a_{1,4} = 1749.9343, a_{2,4} = 198.1757, a_{3,4} = 466.1059, a_{4,2} = 28.879$$

$$a_{i,j} = 0 \text{ (for } i = j \text{)}$$

These Wilson parameters used for the chemical species were taken from Simandl and Svrcak (1991).

The bubble point calculation was carried out according to the steps shown in flow chart in figure 3.13. Acetic acid was selected as j component and saturated pressure of that component was calculated. The temperature for that pressure was then calculated. The saturated pressure values were calculated for that temperature again. This iteration was carried out until a temperature value was converged. An example calculation of how these algebraic equations can be solved is given in Appendix C. The Matlab program written for solving this is shown in Appendix D.

The combination of bubble point calculation and solving algebraic equations was done as shown in flow chart in Figure 3.15. The Matlab program written for solving this is shown in Appendix F. An example calculation of this is also shown in Appendix C.

The Simulation was done until ethyl acetate percentage reduces to 0.05% in the condenser reflux drum.



University of Moratuwa, Sri Lanka.
Electronic Theses & Dissertations
www.lib.mrt.ac.lk

CHAPTER 5

REACTIVE DISTILLATION MODEL SIMULATION RESULTS AND DISCUSSION

5.1 Homogeneous Reaction Kinetics

The value of ratio L_0/V_1 was kept constant for each simulation run varying between 0.85 and 0.99. The total vapor flow rate V_1 was considered as constant and its value was taken as 90 moles/hr in this work. Condenser composition was obtained for different L_0/V_1 ratios, 0.825, 0.85, 0.9, 0.95, 0.975 and 0.99. Reflux ratio R is L_0/D . The Simulation was done until ethyl acetate percentage reduces to 0.05% in the condenser reflux drum. The initial composition of the feed to the reactor and the condenser reflux drum was assumed to be 0.45 mole fraction of acetic acid, 0.45 mole fraction of ethanol and 0.1 mole fraction of water.

The table 5.1 shows the reflux ratio R for different L_0/V_1 values from 0.825 to 0.99 when V_1 is 90 moles/hr.

Table 5.1: Reflux ratio R values

L_0/V_1	0.825	0.85	0.9	0.95	0.975	0.99
R	4.71	5.66	9	19	39	99

5.1.1 Reactor composition variation with time

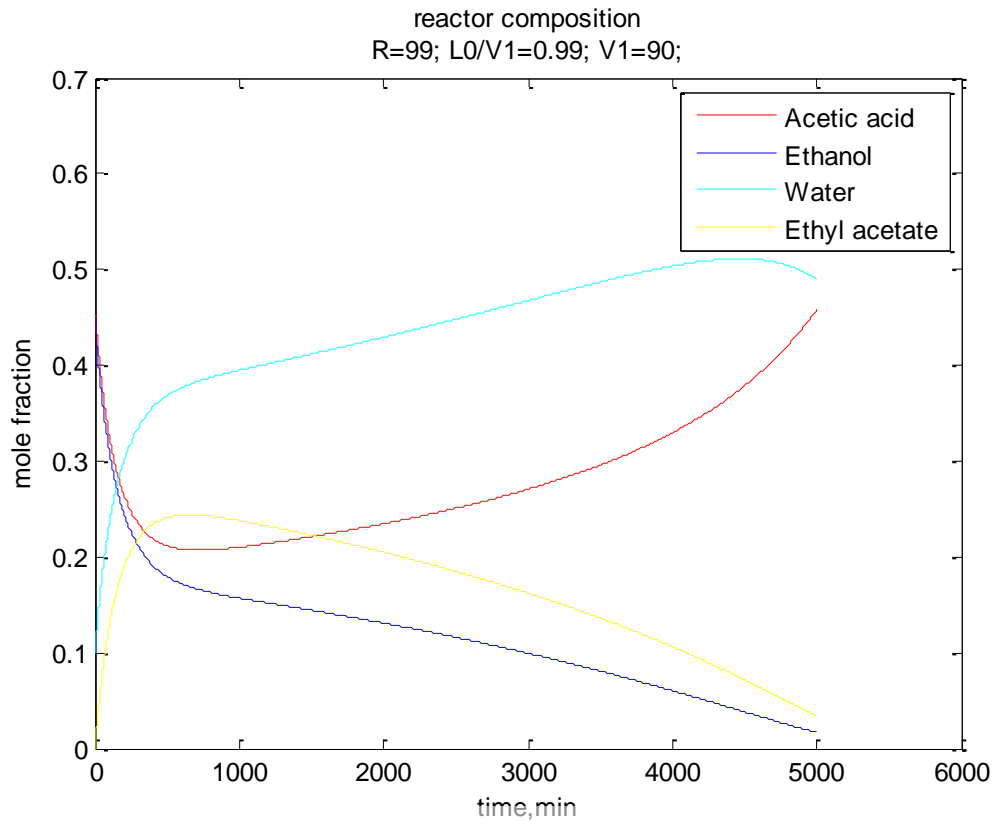

Figure 5.1: Reactor composition variation at reflux 99

For Reflux ratio 99 at $V_1 = 90$ moles/hr reactor composition dynamics is shown in Figure 5.1. As the reaction proceeds acetic acid and Ethanol (reactants) composition decreases and water and ethyl acetate composition increases at first as the reaction take place. Ethanol mole fraction reduces and acetic acid concentration rises due to high boiling point of the mixture after about 600 minutes. Ethyl acetate vaporizes at higher rate after some time and therefore its mole fraction decreases. Although water mole fraction increases as the reaction proceeds it decreases as water starts to vaporize after about 4500 minutes from starting the reaction.

5.1.2 Condenser Composition variation with time

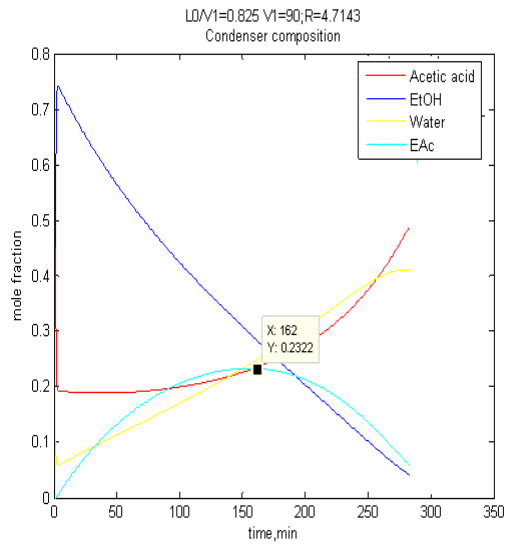

Figure 5.2: Condenser composition
 $L_0/V_1=0.825$

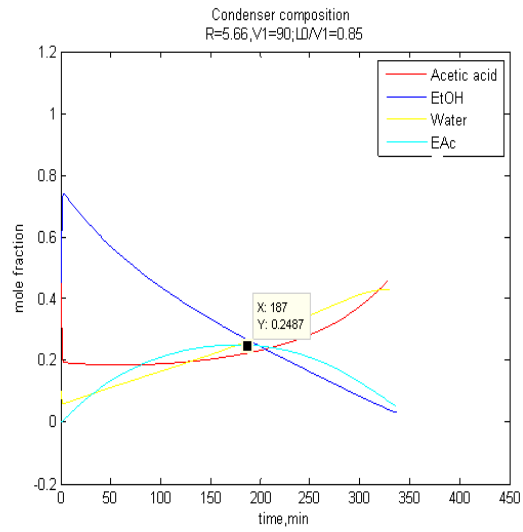

Figure 5.3: Condenser composition
 $L_0/V_1=0.85$

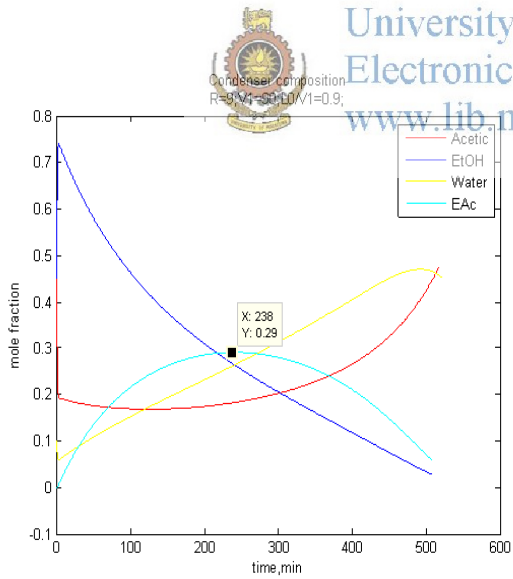

Figure 5.4: Condenser composition
 $L_0/V_1=0.9$

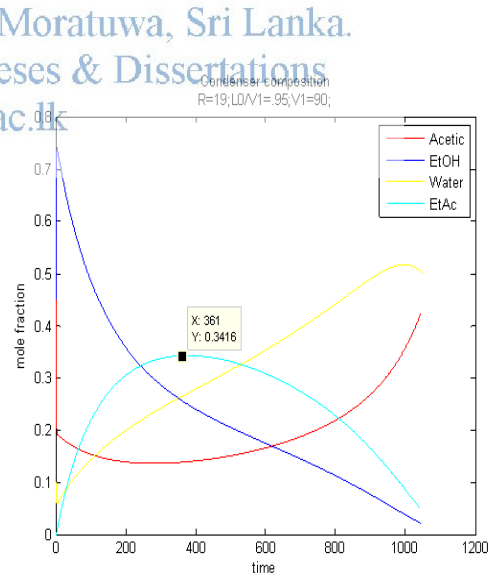

Figure 5.5: Condenser composition
 $L_0/V_1=0.95$

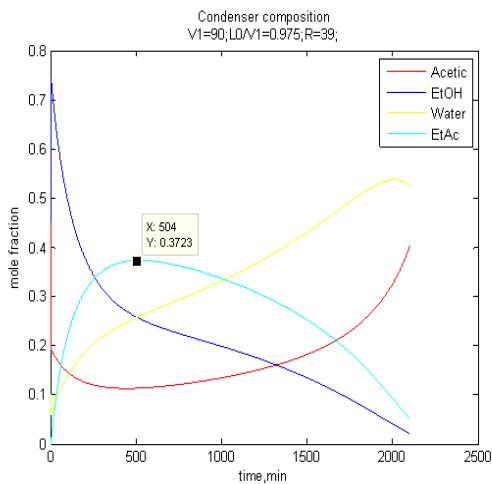

Figure 5.6: Condenser composition
 $L_0/V_1=0.975$

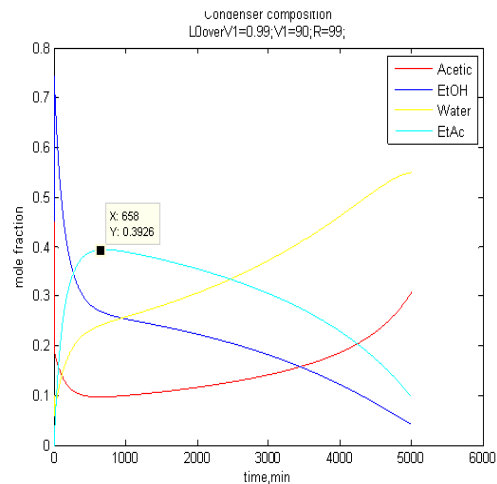

Figure 5.7: Condenser composition
 $L_0/V_1=0.99$

For $L_0/V_1=0.85$, the reflux ratio of 5.66 is needed to keep the condenser holdup at 100 moles. The results show that the batch time for this is around 400 minutes to achieve the 0.05% of ethyl acetate end point in the Condenser reflux drum. Maximum mole fraction of ethyl acetate in the condenser for $L_0/V_1=0.85$ is around 0.23.

The reactants and products mole fraction variations in the condenser reflux drum when $L_0/V_1=0.9$, $R=9$ and $V_1=90$ moles/hr, is shown in figure 5.4. Acetic acid concentration reduces slowly for about 300 minutes and then it starts to increase. Ethanol mole fraction decreases throughout the batch time. Water mole fraction increases nearly linearly. It starts to fall down at the end. In figure 5.4 ethyl acetate mole fraction increases with time and achieves a maximum value and then starts to reduce. Similar results have been reported in the work done by Patel et al (2007). Similar composition variations are also observed for other L_0/V_1 ratio values as seen in Figures 5.2 - 5.7. For the $L_0/V_1=0.9$ the batch time observed is around 550 minutes. As the initial composition assumption made was 0.45, 0.45 and 0.1 for acetic acid, ethanol and water mole fractions respectively, after the initial composition estimation a rapid or abrupt change in compositions of these three species are observed in all the figures from 5.2 to 5.7.

For $L_0/V_1=0.975$ the reflux ratio required is 39. Batch time is around 2100 minutes. Maximum acetate mole fraction is about 0.37 at 504 minutes. For $L_0/V_1=0.99$ the reflux ratio required is 99. Batch time is around 5000 minutes. Maximum mole fraction of ethyl acetate is around 0.39 at about 658 minutes.

The ethyl acetate mole fraction in the condenser shows an increase as the L_0/V_1 ratio increases. The time taken to achieve this maximum also increases as the L_0/V_1 or R is increased.

The table 5.2 shows the effect of reflux ratio on ethyl acetate production. The A_p shown in this table gives the moles of ethyl acetate, T_b is the batch time and Q_t is reactor heat load. Increasing reflux ratio results in an increment of ethyl acetate moles in the distillate and heat duty requirement in the reactor batch. As the reflux ratio increases the batch time also increases and the average production rate reduces. Ethyl acetate mole percentage at the end of the distillation and the maximum purity of ethyl acetate in condenser increases with the increase in reflux ratio. When the reflux ratio increases from 9 to 19 ethyl acetate moles in the distillate increases from 866.54moles to 1051.4moles. Batch time increases 7.01hrs to 13.93hrs. Therefore average production rate reduces 123.49moles/hr to 75.46moles/hr. Reactor heat load also increases from 1.35kJ to 2.70kJ. Depending on the industry requirement either the reflux ratio 9 or 19 or any other reflux ratio could be selected to suite their operation conditions.

Table 5.2: Effect of reflux ratio on EAc production

L_0/V_1 ratio	Reflux ratio	A_p EAc (moles)	$Q_t * 10^6$ kJ	Batch time T_b (hrs)	Average production Rate moles/hr	EAc Mole Percentage in distillate	Maximum Purity of EAc(fraction) In condenser
0.825	4.71	688.8	0.7969	4.16	165.31	17.49	0.2327
0.85	5.66	740.11	0.9201	4.8	154.19	19.01	0.2495
0.9	9	866.54	1.3524	7.01	123.49	22.87	0.2901
0.95	19	1051.4	2.705	13.93	75.46	27.94	0.3419
0.975	39	1174.3	5.54	28.41	41.32	30.61	0.3725
0.99	99	1246.7	14.054	71.78	17.36	32.16	0.3929

5.1.3 Ethyl acetate purity in the accumulated distillate

The distillate taken out from the condenser is accumulated as the output product. This product is referred to as the accumulated distillate. The ethyl acetate composition percentages in the accumulated distillate varying with time for L_0/V_1 ratios 0.825 to 0.99 are shown in figure 5.8.

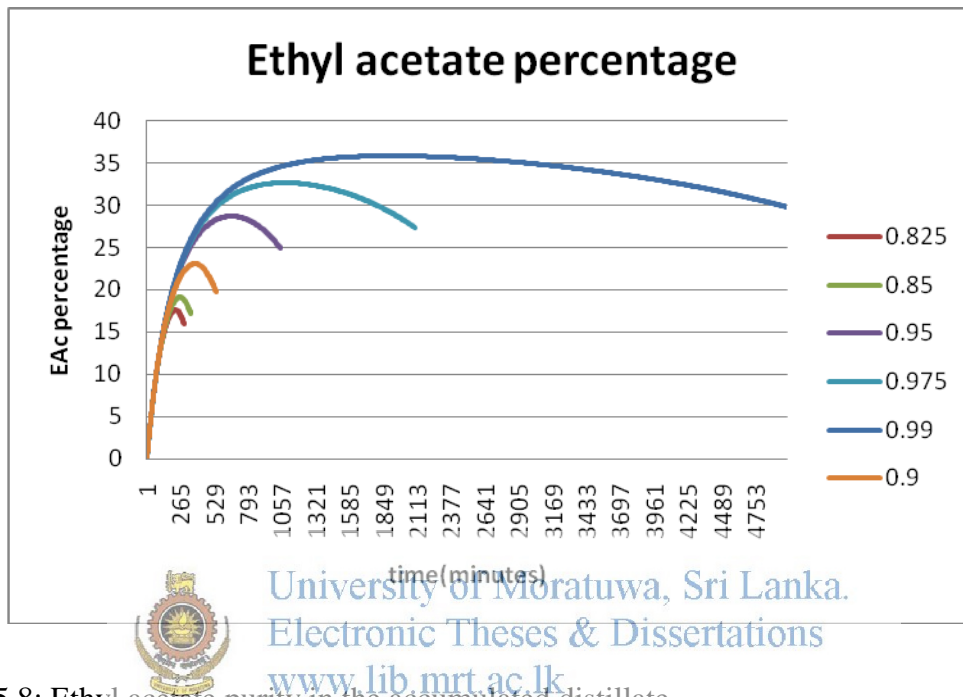

Figure 5.8: Ethyl acetate purity in the accumulated distillate

Ethyl Acetate mole fraction in the accumulated distillate increases with time and achieves a maximum and then it declines for all L_0/V_1 ratios as shown in figure 5.8. The maximum value of ethyl acetate declines with decrease in reflux ratio. Ethyl acetate percentage gets its maximum value at a lesser time as the reflux ratio decreases.

Ethyl acetate mole fraction reduces after achieving a maximum as ethanol and water vaporizes. Similar results have been observed in the work done by Patel et al., (2007). In their study ethyl acetate mole fraction increases rapidly at first and achieves a maximum and then reduces.

5.1.4 Dynamics of reactor temperature

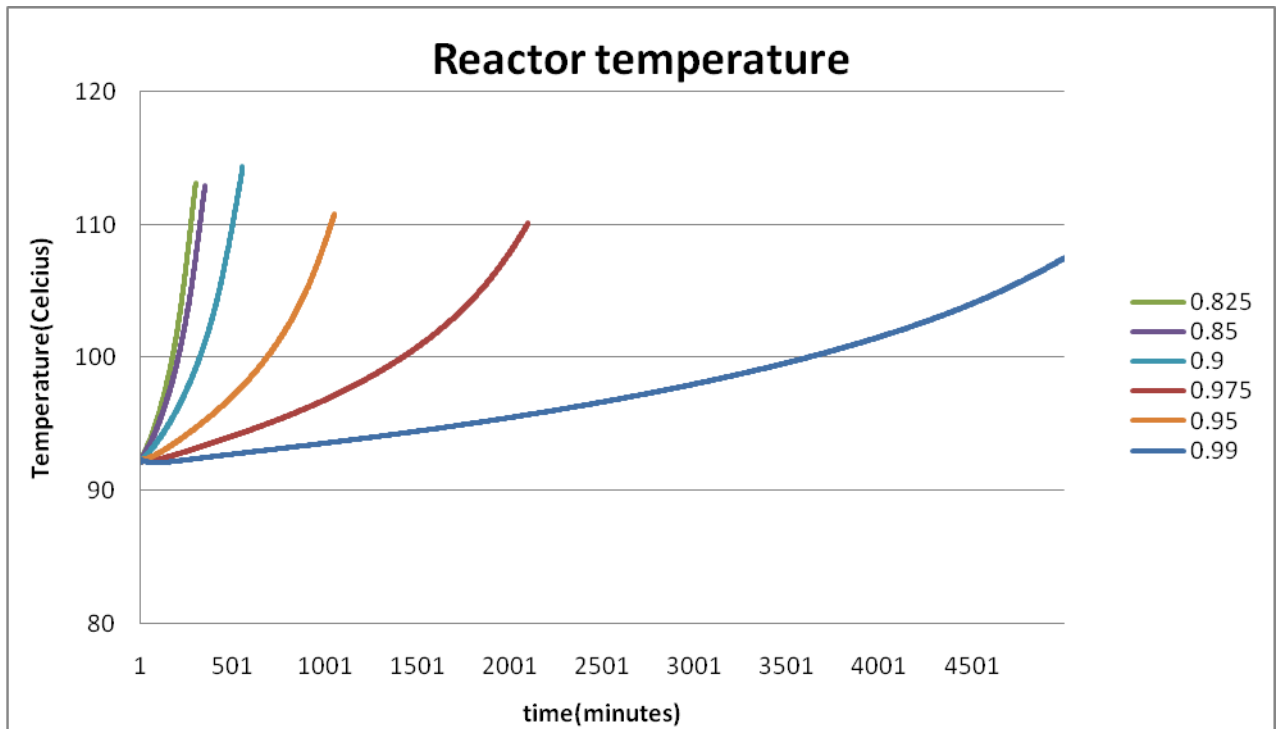

Figure 5.9: Dynamics of reactor temperature

The variation of temperature with time for different reflux ratios in the reactor is shown in figure 5.9. The rate of change of temperature increases with decrease in L_0/V_1 ratio. For all L_0/V_1 ratios, the temperature increases with time.

5.1.5 Conversion of Acetic acid

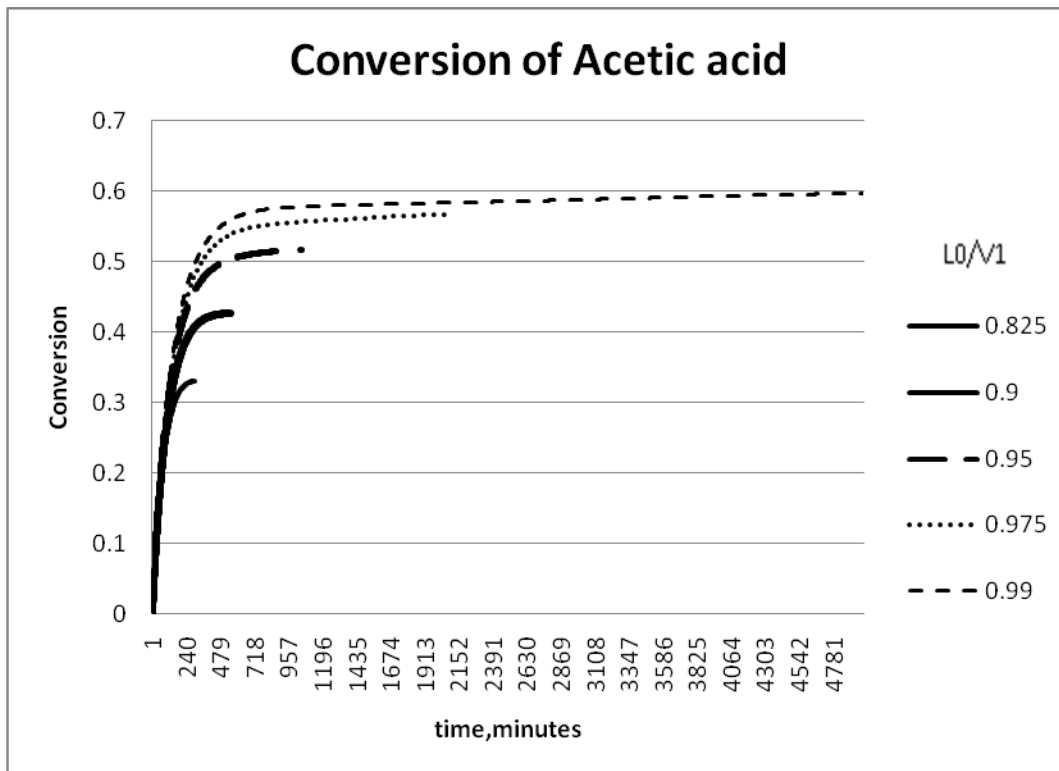

Figure 5.10 Dynamics of conversion of acetic acid with time

The conversion of acetic acid in the reactor batch and condenser reflux drum is shown in figure 5.10. The conversion increases with time and achieves a constant value. The conversion is higher at high reflux ratios and achieves faster.

5.2 Heterogeneous Reaction Kinetics Model Simulation

The simulation results of modeling with the heterogeneous kinetic equation (4.1.7) are discussed in this section. Similar to the homogeneous kinetics modeling study, in this case also the value of L_0/V_1 ratio was kept constant for each simulation run varying between 0.7 and 0.99. The total vapor flow rate V_1 is considered as a constant with the value 90 moles/hr. The simulation was done until ethyl acetate percentage reduces to 0.05% in the condenser reflux drum. The initial composition of the feed to the reactor and the condenser reflux drum was assumed to be 0.45 mole fraction of acetic acid, 0.45 mole fraction of ethanol and 0.1 mole fraction of water.

5.2.1 Condenser composition at various reflux ratios

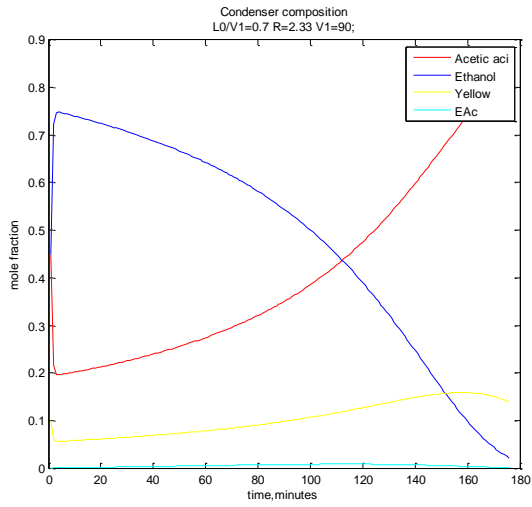

Figure 5.11 Condenser composition for $L_0/V_1=0.7$

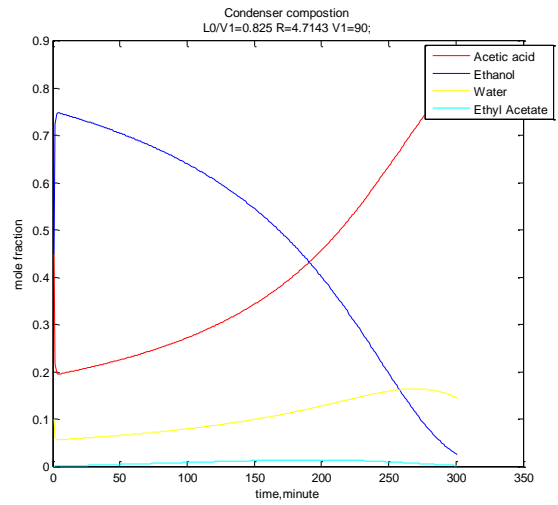

Figure 5.12 Condenser composition for $L_0/V_1=0.825$

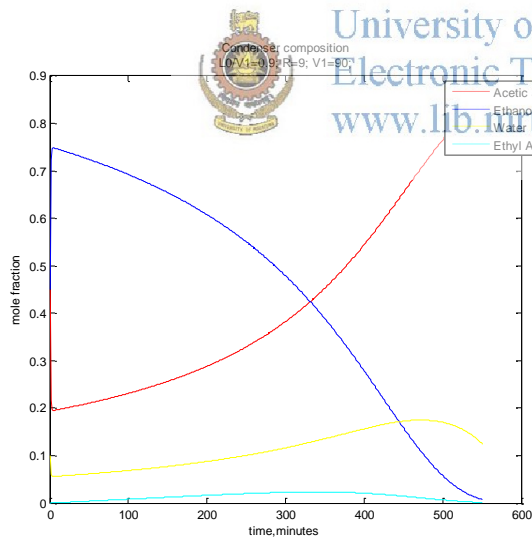
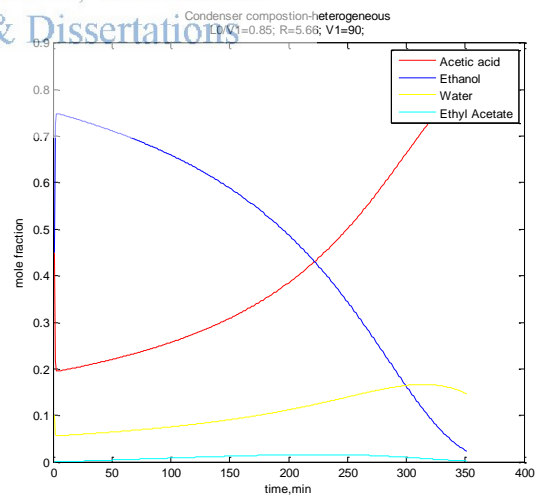

Figure 5.13 Condenser composition
 Figure 5.14 Condenser composition for $L_0/V_1=0.85$



for $L_0/V_1=0.9$

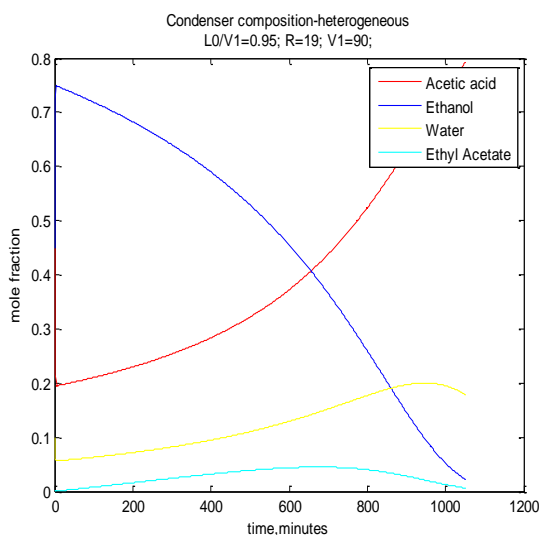

Figure 5.15 Condenser composition for $L_0/V_1=0.95$

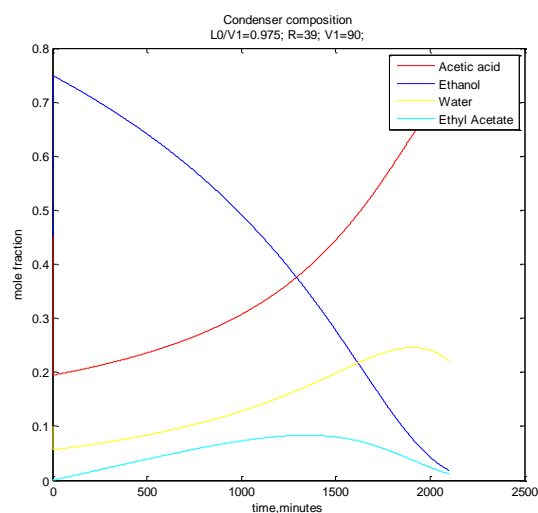

Figure 5.16 Condenser composition for $L_0/V_1=0.975$

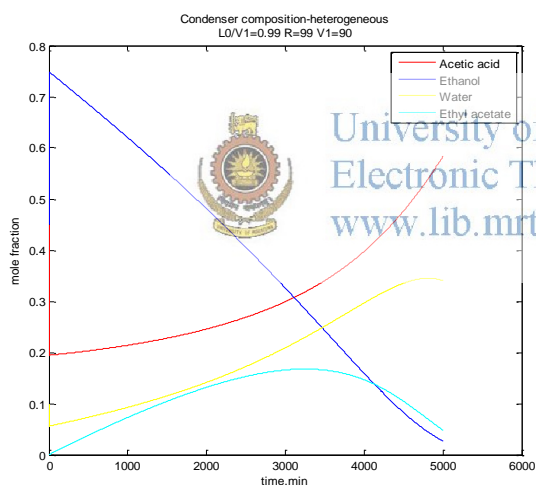

Figure 5.17 Condenser composition for $L_0/V_1=0.99$

Figures 5.11 to 5.17 represent the reactants and products variation for L_0/V_1 ratios 0.7, 0.825, 0.85, 0.9, 0.95, 0.975 and 0.99 when heterogeneous catalyst is used. These graphs show that the maximum ethyl acetate mole fractions are lower than that of the homogeneous catalyst. Increasing L_0/V_1 ratio results in increment of ethyl acetate mole fraction in the condenser similar to the increment results shown in the homogeneous case. Acetic acid and water mole fraction show an increase as the reaction proceeds.

5.2.2 The variation of process parameters with reflux ratios

The accumulated distillate is considered as the product taken out from the condenser and accumulated. The ethyl acetate composition percentage in the accumulated distillate variation with time is shown in Figure 5.18. The variation of reactor temperature and the acetic acid conversion in the reactor batch with time for different L_0/V_1 ratios when heterogeneous kinetics are used are shown in Figure 5.19 and Figure 5.20 respectively.

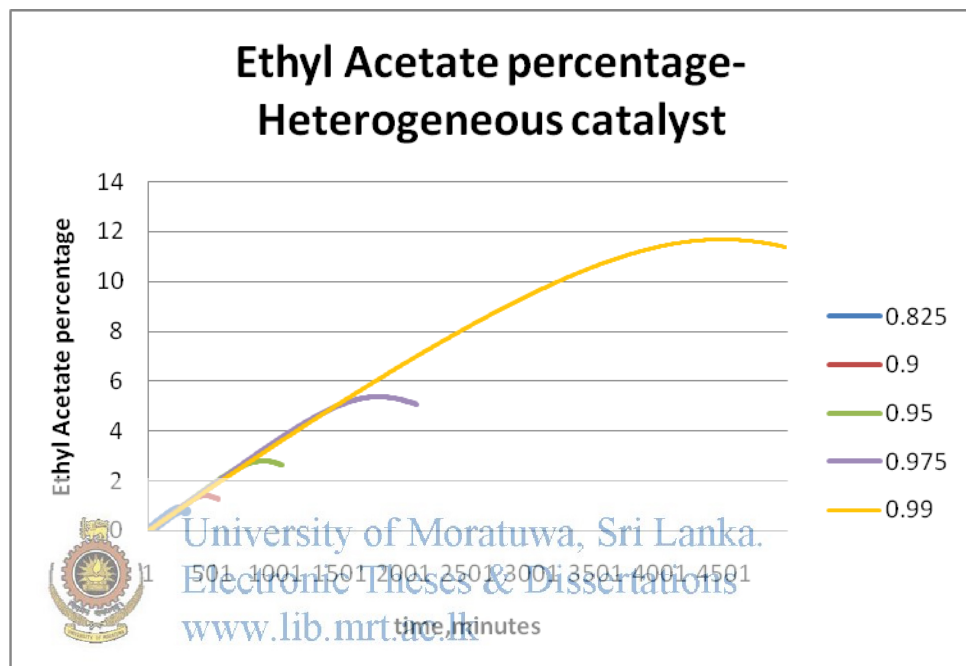

Figure 5.18: Ethyl Acetate percentage in the accumulated distillate when the heterogeneous catalyst is used.

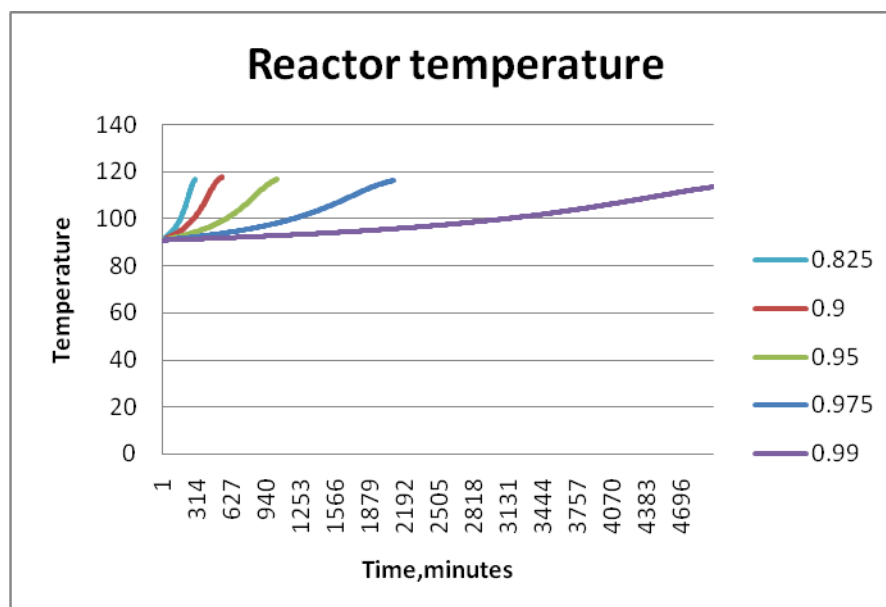

Figure 5.19: Dynamics of reactor temperature ($^{\circ}\text{C}$) for heterogeneously catalyzed system

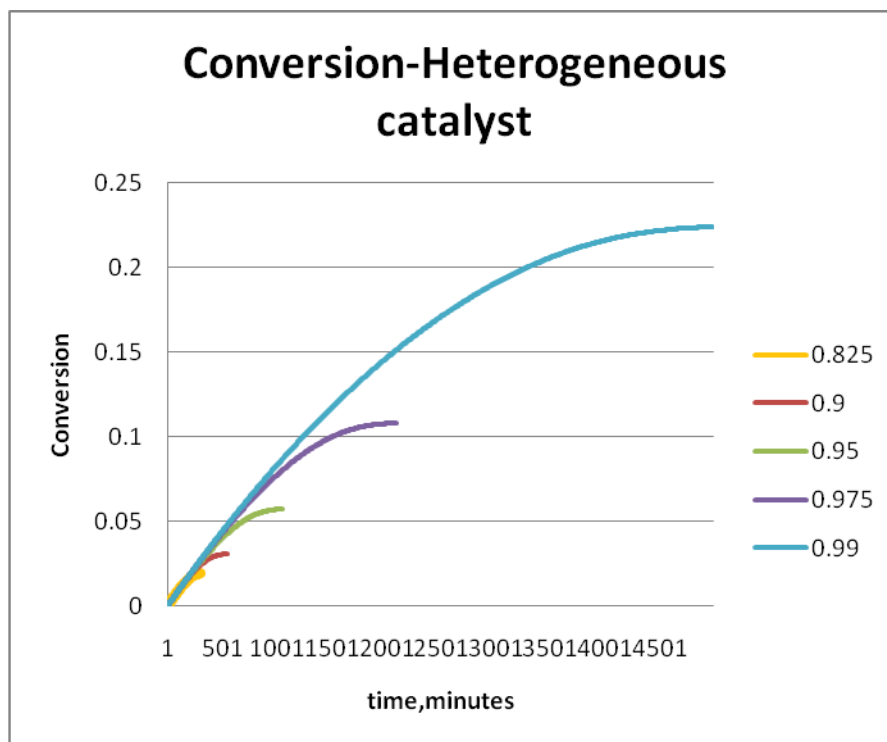

Figure 5.20: Conversion of Acetic acid- in the presence of the heterogeneous catalyst



The initial slopes of the curves in heterogeneous catalyst study shown in figure 5.18 are smaller than that of the study done with homogeneous catalyst (figure 5.8). Ethyl acetate percentage in the accumulated distillate in heterogeneous catalyst is lower than the homogeneous catalyst. The better performance characteristics of the homogeneous catalyst compared to the heterogeneous catalyst used in this work is also shown in the study of De Silva et al (2014). The dynamics of reactor temperature is shown in figure 5.19. At small reflux ratios the temperature of the reactor increases rapidly. The temperature of the reactor increases slowly at high reflux ratios. The conversion of acetic acid in the reactor batch when heterogeneous catalyst is used in the reaction is shown in figure 5.20.

5.2.3 Effect of Reflux Ratio on Ethyl Acetate Production

Table 5.3 Effect of reflux ratio on EAc production-heterogeneous catalyst

L_0/V_1 ratio	Reflux ratio	A_p EAc (moles)	Tb(hrs)	Average production Rate (moles/hour)	EAc Mole Percentage in distillate	Maximum Purity of EAc(fraction) In condenser
0.7	2.33	21.83	2.65	8.23	0.5078	0.0081
0.75	3	26.11	3.18	8.20	0.6077	0.0096
0.825	4.71	38.59	4.98	7.74	0.8197	0.0136
0.85	5.66	44.89	5.81	7.71	0.9519	0.0158
0.9	9	67.19	9.15	7.34	1.3599	0.0234
0.95	19	129.68	17.48	7.41	2.7473	0.045
0.975	39	244.67	34.98	6.99	5.1808	0.0835
0.99	99	501.62	83.31	6.02	11.1495	0.1676

The effect of reflux ratio on accumulated ethyl acetate in distillate (A_p), total batch time (Tb) and the production rate of ethyl acetate for heterogeneous catalytic kinetics study is shown in table 5.3. Ethyl acetate moles in the distillate are low at small reflux ratios. Although the product moles increase as the reflux ratio increases, it leads to higher batch time. Therefore there is not much variation in the average production rate. Considering Table 5.2 and Table 5.3 it is apparent that homogeneous catalyst is more suitable than heterogeneous catalyst studied in this work for reactive distillation.

5.2.4 Average ethyl acetate production rate for initial reactant composition of 50% acetic acid and 50% ethanol

The model for reactive distillation of acetic acid and ethanol having initial mole fractions 0.5 with the cation exchange resin as the heterogeneous catalyst was simulated. The simulation results ethyl acetate moles, average production rate and ethyl acetate mole percentage are shown in table 5.4.

Table 5.4: EAc production rates for various L_0/V_1 for acetic acid to ethanol initial reactant ratio of 1:1 with heterogeneous reaction kinetics

L_0/V_1 ratio	Reflux ratio	Tb(hrs)	Average production Rate(moles/hour)	EAc Mole Percentage In distillate	Maximum Purity of EAc(fraction) In condenser
0.825	4.71	4.98	7.34	0.77	0.0131
0.85	5.66	5.81	7.32	0.90	0.0152
0.9	9	9.15	6.97	1.29	0.0225
0.95	19	17.48	7.40	2.63	0.0437
0.975	39	34.98	6.80	5.03	0.0826
0.99	99	83.31	6.11	11.33	0.1741

The results in table 5.4 and table 5.3 shows that there is not much variation in simulation results for the two different initial reactant compositions used, that is acetic acid ethanol ratio of 1:1 and acetic acid: ethanol: water ratio of 0.45:0.45:0.1.

Ethyl acetate product moles and production rate are higher in acetic acid initial 0.45 mole fraction case compared to 0.5 mole fraction case except in 99 reflux ratio. Ethyl acetate mole percentages in the accumulated distillate at the end of the batch time and the maximum purity of ethyl acetate in the condenser are higher in acetic acid initial 0.45 mole fraction study compared to that of 0.5.

5.3 Comparison with literature results

The reactive distillation modeled results using homogeneous kinetics were compared with the data available in the literature. Patel, Singh, Pareek and Tade(2007) have modeled a batch reactive distillation column for ethyl acetate synthesis. Ten ideal separation stages have been considered for their model and the model simulation shows similar results to this study.

The variation of reactor compositions with time (figure 5.1) show results similar to that of in the study done by Patel et al.,(2007).Both studies show a rise in ethyl acetate mole fraction from zero reaching a maximum value and then gradually falling as time increases. The initial rise in the ethyl acetate mole fraction is due to the high initial rate of reaction. This high initial rate of reaction is due to high reactant concentration assumed at the initial modeling iteration. The reactants concentration reduces as the products are separated in the reactive distillation. Therefore rate of reaction reduces. Acetic acid mole fraction gradually decreases with time as the reactants are consumed and finally an increase is shown in the batch reactor. The Acetic acid has the highest boiling point in the mixture and it retains in the reactor while other components vaporize. Therefore an increment is shown in the final stages of the batch time. Ethanol mole fraction falls as the reaction proceeds and separation takes place.



University of Moratuwa, Sri Lanka.
Electronic Theses & Dissertations
www.lib.mrt.ac.lk

The reactor temperature rises as the reaction and separation proceeds in this work (figure 5.9) and a similar behavior is observed in the study of Patel et al., (2007).

When L_0/V_1 ratio is 0.9 the conversion obtained in this work is 0.42 fraction (figure 5.10). The conversion is 0.65 in Patel *et al.* (2007) when L_0/V_1 is 0.9. The higher conversion in Patel *et al.* (2007) could be because of the 10 ideal separation stages that they have considered in their reactive distillation unit.

It takes 7 hours to achieve the 42% conversion when L_0/V_1 is 0.9 in this research work. In Patel *et al.* (2007) the batch time is 11 hours to achieve 65% conversion when L_0/V_1 is 0.9. Initially conversion rises rapidly due to high rate of reaction. As the ethanol moles are consumed the conversion becomes constant. The conversion is higher at high reflux ratios for both cases.

CHAPTER 6

CONCLUSIONS & RECOMMENDATIONS

6.1 Conclusions

In order to investigate the performance of a batch reactive distillation unit with single separation stage a mathematical model was developed. The model was applied in a reactive distillation of acetic acid and ethanol and simulated for a total reactor content of 5000 moles by varying the reflux ratio. Ethyl acetate mole percentage in the accumulated distillate was obtained for these different reflux ratios. Homogeneous kinetics and heterogeneous kinetics were studied.

The most suitable reflux ratios for the reactive distillation using sulphuric acid homogeneous catalyst are 0.9 or 0.95. When the reflux ratio increases from 0.9 to 0.95, ethyl acetate moles in the distillate increased from 866.5 to 1051.4 and the production rate reduced from 123.49 moles/hr to 75.46 moles/hr. Depending on the industry requirement the reflux ratio 0.9 or 0.95 can be selected. The increase of reflux ratio results in an increment of reactor heat load. The heterogeneous kinetics study under the conditions of the reactive distillation modeled in this work did not show good results. It can be concluded that homogeneous catalyst is more suitable than the heterogeneous catalyst studied in this work.

The model developed in this work for modeling reactive distillation can be used for different reaction kinetics of acetic acid esterification with ethanol. The computer software program developed to use in the matlab environment can be used to find the concentrations of reactants and products at a given time. By comparing the simulation results the most suitable reactive distillation operating conditions can be selected.

6.2 Recommendations for future work

This modeling and simulation work and the matlab programme developed can be also used for other equilibrium reactions that can be applied in reactive distillation. The optimum conditions for batch reactive distillation can be obtained for those equilibrium reactions. Relevant vapor and liquid equilibrium data and kinetic data should be available to use this program.

The suitable operating conditions can be obtained for different heterogeneous catalysts as well as homogeneous catalysts by using their reaction kinetic data. This modeling work can be further extended by adding more number of separation stages to the reactive distillation column.

The simulation can be further done for different batch sizes and with different initial reactant mole compositions. This model can be validated with experimental work.



University of Moratuwa, Sri Lanka.
Electronic Theses & Dissertations
www.lib.mrt.ac.lk

REFERENCES

Almeida-Rivera, C.P., Swinkels, P.L.J., & Grievink, J. (2004). Designing reactive distillation processes: present and future. *Computers and Chemical engineering*, 28, 1997-2020.

Araromi, D.O., Sonibare, J.A., Justice, E.O., & Afolabi, T.J. (2011). Batch reactive distillation studies for Acetic acid Recovery from Aqueous Solution. *Advances in Biotechnology & Chemical Processes*, 1, 1-11.

Bhatia, S., Mohamed, A.R., Ahmad, A.L., & Chin, S.Y. (2007). Production of Isopropyl palmitate in a catalytic distillation column: Comparison between experimental and simulation studies. *Computers and Chemical engineering*, 31, 1187-1198.

Bhatt, K., & Patel, N.M. (2012). Generalized Modeling and Simulation of reactive distillation: Esterification. *Advances in Applied Science Research*, 3(3), 1346-1352.



University of Moratuwa, Sri Lanka.
Electronic Theses & Dissertations
www.lib.mrt.ac.lk

Chiang, S.F., Kuo, C.L., Yu, C.C., Wong, D.S.H. (2002). Design Alternatives for the Amyl acetate Process: Coupled Reactor/Column and Reactive Distillation. *Industrial and Engineering Chemistry Research*, 41(3), 3233-3246. doi:10.1021/ie010358j

Chen, F., Huss, R.S., Malone, M.F., & Doherty M.F. (2000). Simulation of kinetic effects in reactive distillation. *Computers and chemical engineering*, 24, 2457-2472.

De Silva, E.C.L., Bamunusingha, B.A.N.N., Gunasekera, M.Y. (2014). Heterogeneous kinetic Study for Esterification of Acetic acid with Ethanol. *Engineer The Institution of Engineers Sri Lanka*, 42(1), 9-15.

Estrada-villagranna, A.D., & Bogle, I.D.L. (1999). Exploring the interaction between flows and composition in reactive distillation. *Computers and Chemical engineering supplement*, S339-S342

Edreder, E.A., Mujtaba, I.M., & Emtir M. (2011). Optimal operation of different types of batch reactive distillation columns used for hydrolysis of methyl lactate to lactic acid. *Chemical Engineering Journal*, 172, 467-475.

Georgiadis, M.C., Schenk, M., Pistikopoulos, E.N., & Gani, R. (2002). The interactions of design, control and operability in reactive distillation systems. *Computers and chemical engineering*, 26, 735-746.

Harmsen, G.J. (2007). Reactive distillation: The front-runner of industrial process intensification, A full review of commercial applications, research, scale-up, design and operation. *Chemical engineering and processing*, 46, 774-780



University of Moratuwa, Sri Lanka.
Electronic Theses & Dissertations
www.lib.mrt.ac.lk

Hiwale, R.S., Bhate, N.V., Mahajan, Y.S., & Mahajani, S.M. (2004). Industrial applications of reactive distillation: Recent trends. *International journal of chemical reactor engineering*, vol 2.

Huss, R.S., Chen, F., Malone, M.F., & Doherty, M.F. (2003). Reactive distillation for methyl acetate production. *Computers and Chemical engineering*, 27, 1855-1866.

Jana, A.K., & Adari, P.V.R.K. (2009). Nonlinear state estimation and control of a batch reactive distillation. *Chemical engineering Journal*, 150, 516-526.

Katariya, A.M., Kamath, R.S., Moudgalya, K.M., & Mahajani, S.M. Non-equilibrium stage modeling and non-linear dynamic effects in the synthesis of TAME by reactive distillation. *Computers and Chemical engineering*, 32, 2243-2255.

Kenig, E.Y., & Bader, H. (2001). Investigation of ethyl acetate reactive distillation process. *Chemical Engineering science*, 56, 6185-6193.

Keller, T., Gorak, A. (2013). Modeling of homogeneously catalysed reactive distillation processes in packed columns, Experimental model validation. *Computers and Chemical Engineering*, 48, 74-88.

Krzysztof, A., & Francoise, D. (1996). Dynamic simulation of the Multi component Reactive Distillation. *Chemical Engineering Science* , vol 51, No 18, PP4237-4252.

 University of Moratuwa, Sri Lanka.
Electronic Theses & Dissertations
www.lib.mrt.ac.lk
Lai, I.K., Liu, Y.C., Yu, C.C., Lee, M.J., & Hung, H.P. (2008). Production of high purity ethyl acetate using reactive distillation: Experimental and start-up procedure. *Chemical Engineering and Processing*, 47, 1831-1843.

Lee, J.H., & Dudukovic, M.P., (1998). A Comparison of the equilibrium and non equilibrium models for multi component reactive distillation column. *Computers and Chemical Engineering*, 23, 159-172.

Liu, J, Yang, B., Lu, S., & Yi, C.(2013). Multi-scale study of reactive distillation. *Chemical Engineering Journal*, 225, 280-291.

Maiti, D., Jana, A.K., Samantha A.N. (2013). Intensified thermal integration in Batch Reactive Distillation. *Applied Energy*, 103, 290-297.

Muhammad, A., Arfaj, A., Luyben, W.L. (2002). Comparative control study of ideal and Methyl acetate reactive distillation. *Chemical Engineering Science*, 57, 5039-5050.

Murat, M.N., Mohamed, A.R., & Bhatia, S. (2003). Modeling of a reactive distillation column. Methyl tertiary butyl ether (MTBE) Simulation studies. *ITUM Engineering Journal*, vol.4, No.2.

Patel, R., Singh, K., Pareek, V., Tade, M.O. (2007). Dynamic Simulation of Reactive Batch Distillation column for Ethyl Acetate Synthesis. *Chemical Product and Process Modeling*, vol.2, Iss.2, Art 5.

Rahul, M., Kumar, M.V.P., Dwivedi, D., & Kaistha, N.(2009). An efficient algorithm for rigorous dynamic simulation of reactive distillation columns. *Computers and Chemical Engineering*, 33, 1336-1343.



University of Moratuwa, Sri Lanka
Electronic Theses & Dissertations
www.lib.mrt.ac.lk

Radulescu, G., Gangadwala, J., Paraschiv, N., Kienle, A., & Sundmacher, K. (2009). Dynamics of reactive distillation processes with potential liquid phase splitting based on equilibrium stage models. *Computers and Chemical engineering*, 33, 590-597.

Schneider, R., Noeres, C., Kreul, L.U., & Gorak, A. (2001). Dyanamic modeling and simulation of reactive batch distillation. *Computers and Chemical engineering*, 25, 169-176

Simandl, J., & Svrcek, W.Y. (1991). Extension of the simultaneous-solution and inside-outside algorithms to distillation with chemical reactions. *Computers chemical engineering* , vol.15, pp.337-348.

Singh, B.P., Singh, R., Kumar, M.V.P., Kaistha, N. (2005). Steady-state analysis for reactive distillation control: An MTBE Case study. *Journal of loss prevention in the Process Industries*, vol.18, 283-292.

Smith, J.M., Van Ness, H.C., & Abbot, M.M., (1996). Introduction to Chemical Engineering Thermodynamics, New York: The McGraw Hill companies, Inc.

Svandova, Z., Labovsky, J., Markos, J., & Jelemensky, L. (2009). Impact of mathematical selection on prediction of steady state and dynamic behavior of a reactive distillation column. *Computers and Chemical engineering*, 33, 788-793.

Taylor, R., & Krishna, R. (2000). Modeling reactive distillation-review, *Chemical Engineering Science*, 55, 5183-5229.



University of Moratuwa, Sri Lanka.
Electronic Theses & Dissertations
www.lib.mrt.ac.lk

Appendix A: An example calculation of parameters used for bubble point calculation

Acetic acid: $V_{c1} = 179.7 \text{ cm}^3 / \text{mol}$; $Z_{c1} = 0.211$; $T_{c1} = 592 \text{ K}$

Ethanol: $V_{c2} = 167.0 \text{ cm}^3 / \text{mol}$; $Z_{c1} = 0.240$; $T_{c1} = 513.9 \text{ K}$

Water: $V_{c1} = 55.9 \text{ cm}^3 / \text{mol}$; $Z_{c1} = 0.229$; $T_{c1} = 647.1 \text{ K}$

Ethyl acetate: $V_{c1} = 286.0 \text{ cm}^3 / \text{mol}$; $Z_{c1} = 0.255$; $T_{c1} = 523.3 \text{ K}$

(a) Calculating molar volumes

$$V^{sat} = V_c Z_c \left(1 - \frac{T}{T_c}\right)^{0.2857}$$

Assume Temperature (T) 370K

$$V_1^{sat} = 179.7 \text{ cm}^3 / \text{mol} \times 0.211 \left(1 - \frac{370}{592}\right)^{0.2857} = 55.45817$$

$$V_2^{sat} = 167.0 \text{ cm}^3 / \text{mol} \times 0.24 \left(1 - \frac{370}{513.9}\right)^{0.2857} = 61.92824$$

$$V_3^{sat} = 55.90 \text{ cm}^3 / \text{mol} \times 0.229 \left(1 - \frac{370}{647.1}\right)^{0.2857} = 17.579306$$

$$V_4^{sat} = 286.0 \text{ cm}^3 / \text{mol} \times 0.255 \left(1 - \frac{370}{523.3}\right)^{0.2857} = 109.2657$$

(b) Determination of temperature dependent parameters

$$G_{ij} = \frac{V_j}{V_i} \exp\left(\frac{-a_{ij}}{RT}\right)$$

$$G_{1,1} = \frac{V_1}{V_1} \exp\left(\frac{-a_{1,1}}{RT}\right) = 1$$

$$G_{1,2} = \frac{V_2}{V_1} \exp\left(\frac{-a_{1,2}}{RT}\right) = \frac{61.928}{55.458} \exp(130.6527/370) = 1.589567311$$

$$G_{1,3} = \frac{V_3}{V_1} \exp\left(\frac{-a_{1,3}}{RT}\right) = \frac{17.579306}{55.458} \exp(-2.0311/370) = 0.3152488279$$

$$G_{1,4} = \frac{V_4}{V_1} \exp\left(\frac{-a_{1,4}}{RT}\right) = \frac{109.2657}{55.458} \exp(-1749.9343/370) = 0.0173980767$$

$$G_{2,1} = \frac{V_1}{V_2} \exp\left(\frac{-a_{2,1}}{RT}\right) = \frac{55.458}{61.928} \exp(-101.6588/370) = 0.6803826245$$

$$G_{2,2} = \frac{V_2}{V_2} \exp\left(\frac{-a_{2,2}}{RT}\right) = 1$$

 University of Moratuwa, Sri Lanka.
Electronic Theses & Dissertations
www.lib.mrt.ac.lk

$$G_{2,3} = \frac{V_3}{V_2} \exp\left(\frac{-a_{2,3}}{RT}\right) = \frac{17.579306}{61.928} \exp(-198.1757/370) = 0.166150711$$

$$G_{2,4} = \frac{V_4}{V_2} \exp\left(\frac{-a_{2,4}}{RT}\right) = \frac{109.2657}{61.928} \exp(-288.2011/370) = 0.8096835545$$

$$G_{3,1} = \frac{V_1}{V_3} \exp\left(\frac{-a_{3,1}}{RT}\right) = \frac{55.458}{17.579306} \exp(-403.1564/370) = 1.061084683$$

$$G_{3,2} = \frac{V_2}{V_3} \exp\left(\frac{-a_{3,2}}{RT}\right) = \frac{61.928}{17.579306} \exp(-466.1059/370) = 0.9995044523$$

$$G_{3,3} = \frac{V_3}{V_3} \exp(0) = 1$$

$$G_{3,4} = \frac{V_4}{V_3} \exp\left(\frac{-a_{3,4}}{RT}\right) = \frac{109.2657}{17.579306} \exp(-1195.67/370) = 0.2454945763$$

$$G_{4,1} = \frac{V_1}{V_4} \exp\left(\frac{-a_{4,1}}{RT}\right) = \frac{55.458}{109.2657} \exp(464.1529/370) = 1.779461417$$

$$G_{4,2} = \frac{V_2}{V_4} \exp\left(\frac{-a_{4,2}}{RT}\right) = \frac{61.928}{109.2657} \exp(-28.8790/370) = 0.5242107598$$

$$G_{4,3} = \frac{V_3}{V_4} \exp\left(\frac{-a_{4,3}}{RT}\right) = \frac{17.579306}{109.2657} \exp(-26981.1/370) = 3.4430 \times 10^{-33}$$

$$G_{4,4} = \frac{V_4}{V_4} \exp(0) = 1$$

(c) Determination of activity coefficient



University of Moratuwa, Sri Lanka.
Electronic Theses & Dissertations
www.lib.mrt.ac.lk

$$\ln \gamma_i = 1 - \ln \left(\sum_j x_j G_{ij} \right) - \sum_k \left(\frac{x_k G_{ki}}{\sum_j x_j G_{kj}} \right)$$

$$\ln \gamma_1 = 1 - \ln(x_1 G_{1,1} + x_2 G_{1,2} + x_3 G_{1,3} + x_4 G_{1,4}) - \frac{x_1 G_{1,1}}{x_1 G_{1,1} + x_2 G_{1,2} + x_3 G_{1,3} + x_4 G_{1,4}} \dots$$

$$\ln \gamma_1 = -0.0551539989$$

$$\gamma_1 = \underline{\underline{0.9463394014}}$$

$$\ln \gamma_2 = 1 - \ln(x_1 G_{2,1} + x_2 G_{2,2} + x_3 G_{2,3} + x_4 G_{2,4}) - \frac{x_1 G_{1,2}}{x_1 G_{1,1} + x_2 G_{1,2} + x_3 G_{1,3} + x_4 G_{1,4}} \dots$$

$$\ln \gamma_2 = 0.5781461348$$

$$\gamma_2 = \underline{\underline{1.782730423}}$$

$$\ln \gamma_3 = 1 - \ln(x_1 G_{3,1} + x_2 G_{3,2} + x_3 G_{3,3} + x_4 G_{3,4}) - \frac{x_1 G_{1,3}}{x_1 G_{1,1} + x_2 G_{1,2} + x_3 G_{1,3} + x_4 G_{1,4}} \dots$$

$$\ln \gamma_3 = 0.6604718476$$

$$\gamma_3 = \underline{\underline{1.935705477}}$$

$$\ln \gamma_4 = 1 - \ln(x_1 G_{4,1} + x_2 G_{4,2} + x_3 G_{4,3} + x_4 G_{4,4}) - \frac{x_1 G_{4,3}}{x_1 G_{1,1} + x_2 G_{1,2} + x_3 G_{1,3} + x_4 G_{1,4}} \dots$$

$$\ln \gamma_4 = 0.4620788076$$

$$\gamma_4 = \underline{\underline{1.587370395}}$$

(d) Calculating vapor pressure

Anotoine equation for vapour pressure  University of Moratuwa, Sri Lanka.
Electronic Theses & Dissertations
www.lib.mrt.ac.lk

$$\log P^{sat} = A - \frac{B}{T + C}$$

For Acetic acid

$$A = 7.5596, B = 1644.05, C = 233.524$$

$$P_1^{sat} = 383.063 \text{ mmHg}$$

For Ethanol

$$A = 8.20417, B = 1642.89, C = 230.3$$

$$P_2^{sat} = 1519.83 \text{ mmHg}$$

For Water

$$A = 8.07131, B = 1730.63, C = 233.426$$

$$P_3^{sat} = 678.202 \text{ mmHg}$$

For Ethyl Acetate

$$A = 7.2597, B = 1369.41, C = 235.5$$

$$P_4^{sat} = 1378.21 \text{ mmHg}$$



University of Moratuwa, Sri Lanka.
Electronic Theses & Dissertations
www.lib.mrt.ac.lk

Appendix B: bubble point temperature determination example calculation

First Iteration of bubble point calculation

$P=760\text{mmHg}$

Let's assume

(1) Acetic acid mole fraction=0.45

(2) Ethanol mole fraction=0.45

(3) Water mole fraction=0.1

(4) Ethyl acetate mole fraction=0

$$T_i^{sat} = \frac{B_i}{A_i - \log P} - C_i$$

For Acetic acid $A = 7.5596, B = 1644.05, C = 233.524$

$$T_1^{sat} = 117.86$$



University of Moratuwa, Sri Lanka.
Electronic Theses & Dissertations
www.lib.mrt.ac.lk

For Ethanol $A = 8.20417, B = 1642.89, C = 230.3$

$$T_2^{sat} = 78.32$$

For Water $A = 8.07131, B = 1730.63, C = 233.426$

$$T_3^{sat} = 100$$

For Ethyl Acetate $A = 7.2597, B = 1369.41, C = 235.5$

$$T_4^{sat} = 77.23$$

$$T = \sum_i x_i T_i^{sat} = x_1 T_1^{sat} + x_2 T_2^{sat} + x_3 T_3^{sat} + x_4 T_4^{sat}$$

$$T = 98.28^{\circ}\text{C}$$

$$\log P_i^{sat} = A_i - \frac{B_i}{T + C_i}$$

$$P_1^{sat} = 14375.13 \quad P_2^{sat} = 114.038 \quad P_3^{sat} = 0.6776 \quad P_4^{sat} = 3.1569$$

$$\ln \gamma_i = 1 - \ln \sum_j x_j \Lambda_{i,j} - \sum_k \frac{x_k \Lambda_{ki}}{\sum_j x_j \Lambda_{kj}}$$

$$\Lambda_{ij} = \frac{V_j}{V_i} \exp \frac{-a_{ij}}{RT}$$

$$a_{1,2} = -130.6527 \quad a_{2,1} = 101.6588 \quad a_{3,1} = 403.1564 \quad a_{4,1} = -464.1529$$

$$a_{1,3} = 2.0311 \quad a_{2,3} = 198.1757 \quad a_{3,2} = 466.1059 \quad a_{4,2} = 28.8790$$

$$a_{1,4} = 1749.9343 \quad a_{2,4} = 198.1757 \quad a_{3,2} = 466.1059 \quad a_{4,2} = 28.879$$

$$a_{i,j} = 0 \text{ (for } i = j \text{)}$$

(1) Acetic acid: $V_{c1} = 179.7 \text{ cm}^3 / \text{mol}; Z_{c1} = 0.211; T_{c1} = 592 \text{ K}$

(2) Ethanol: $V_{c2} = 167.0 \text{ cm}^3 / \text{mol}; Z_{c2} = 0.240; T_{c2} = 513.9 \text{ K}$

(3) Water: $V_{c1} = 55.9 \text{ cm}^3 / \text{mol}; Z_{c1} = 0.229; T_{c1} = 647.1 \text{ K}$

(4) Ethyl acetate: $V_{c1} = 286.0 \text{ cm}^3 / \text{mol}; Z_{c1} = 0.255; T_{c1} = 523.3 \text{ K}$

$$V^{sat} = V_c Z_c \left(1 - \frac{T}{T_c}\right)^{0.2857}$$

$$T = 98.28$$

$$V_1 = 1.550876 \quad V_2 = 1.423288 \quad V_3 = 1.409967 \quad V_4 = 1.52938$$

$$\Lambda_{1,1} = 1 \quad \Lambda_{1,2} = 1.344 \quad \Lambda_{1,3} = 0.903 \quad \Lambda_{1,4} = 0.005903543$$

$$\Lambda_{2,1} = 0.809382492 \quad \Lambda_{2,2} = 1.009447632 \quad \Lambda_{2,3} = 0.554864221 \quad \Lambda_{2,4} = 0.462530073$$

$$\Lambda_{3,1} = 0.338271289 \quad \Lambda_{3,2} = 0.258238087 \quad \Lambda_{3,3} = 1 \quad \Lambda_{3,4} = 0.024490565$$

$$\Lambda_{4,1} = 3.941342859 \quad \Lambda_{4,2} = 0.855252092 \quad \Lambda_{4,3} = 0 \quad \Lambda_{4,4} = 1$$

$$\ln \gamma_i = 1 - \ln \sum_j x_j \Lambda_{i,j} - \sum_k \frac{x_k \Lambda_{ki}}{\sum_j x_j \Lambda_{kj}}$$

$$\ln \gamma_1 = -0.03929 \quad \gamma_1 = 0.961471$$

$$\ln \gamma_2 = 0.037237 \quad \gamma_2 = 1.037939$$

$$\ln \gamma_3 = 1.010128 \quad \gamma_3 = 2.745953$$

$$\ln \gamma_4 = 0.03834 \quad \gamma_4 = 1.039085$$

$$P_j^{sat} = \frac{P}{\sum_i (x_i \gamma_i / \Phi_i) (P_i^{sat} / P_j^{sat})}$$

Select Acetic acid as j component from the set (i)

$$P_j^{sat} = 183.607$$

Calculate Temperature



University of Moratuwa, Sri Lanka.
Electronic Theses & Dissertations
www.lib.mrt.ac.lk

$$T = \frac{B_j}{A_j - \ln P_j^{sat}} - C_j \quad T = 76.92536$$

$$\log P_i^{sat} = A_i - \frac{B_i}{T + C_i}$$

$$P_1^{sat} = 3536.322 \quad P_2^{sat} = 36190.02 \quad P_3^{sat} = 9345.951 \quad P_4^{sat} = 38788.75$$

$$y_i = \frac{x_i \gamma_i P_i^{sat}}{P}$$

$$y_1 = 2.013199 \quad y_2 = 22.24128 \quad y_3 = 3.376782 \quad y_4 = 0$$

$$T = 76.92536$$

$$\Lambda_{1,1} = 1 \quad \Lambda_{1,2} = 1.3296 \quad \Lambda_{1,3} = 0.9085 \quad \Lambda_{1,4} = 0.00662$$

$$\Lambda_{2,1} = 0.8170055 \quad \Lambda_{2,2} = 1.001833 \quad \Lambda_{2,3} = 0.56669 \quad \Lambda_{2,4} = 0.470607162$$

$$\Lambda_{3,1} = 0.34593 \quad \Lambda_{3,2} = 0.2645796 \quad \Lambda_{3,3} = 1 \quad \Lambda_{3,4} = 0.0265743$$

$$\Lambda_{4,1} = 3.83674 \quad \Lambda_{4,2} = 0.8589740 \quad \Lambda_{4,3} = 0 \quad \Lambda_{4,4} = 1$$

$$\ln \gamma_i = 1 - \ln \sum_j x_j \Lambda_{i,j} - \sum_k \frac{x_k \Lambda_{ki}}{\sum_j x_j \Lambda_{kj}}$$

$$\ln \gamma_1 = -0.03776 \quad \gamma_1 = 0.962942$$

$$\ln \gamma_2 = 0.02238 \quad \gamma_2 = 1.022632$$

$$\ln \gamma_3 = 1.06441 \quad \gamma_3 = 2.899127$$

$$\ln \gamma_4 = 0.000163 \quad \gamma_4 = 1.000163$$

$$P_j^{sat} = \frac{P}{\sum_i (x_i \gamma_i / \Phi_i) (P_i^{sat} / P_j^{sat})}$$

Select Acetic acid as j component from the set (i)



University of Moratuwa, Sri Lanka.
Electronic Theses & Dissertations
www.lib.mrt.ac.lk

$$P_j^{sat} = 147.7789$$

Calculate Temperature

$$T = \frac{B_j}{A_j - \ln P_j^{sat}} - C_j \quad T = 71.49526$$

By Iterating

Table 3.2: Bubble point temperature and vapor composition

Temperature	Y ₁	Y ₂	Y ₃	Y ₄
98.28026	2.013199	22.24128	3.376782	0
76.92541	1.317713	15.55649	2.37511	0
71.49528	1.138841	13.78373	2.096188	0

Proceed the iteration till $\sum y_i = 1$.



University of Moratuwa, Sri Lanka.
Electronic Theses & Dissertations
www.lib.mrt.ac.lk

Appendix C: Solving model equations

First Iteration of bubble point calculation

$P=760\text{mmHg}$

Let us assume

(1) Acetic acid mole fraction=0.45

(2) Ethanol mole fraction=0.45

(3) Water mole fraction=0.1

(4) Ethyl acetate mole fraction=0

$$T_i^{sat} = \frac{B_i}{A_i - \log P} - C_i$$

For Acetic acid $A = 7.5596, B = 1644.05, C = 233.524$

$$T_1^{sat} = 117.86$$

For Ethanol $A = 8.20417, B = 1642.89, C = 230.3$



University of Moratuwa, Sri Lanka.
Electronic Theses & Dissertations
www.lib.mrt.ac.lk

$$T_2^{sat} = 78.32$$

For Water $A = 8.07131, B = 1730.63, C = 233.426$

$$T_3^{sat} = 100$$

For Ethyl Acetate $A = 7.2597, B = 1369.41, C = 235.5$

$$T_4^{sat} = 77.23$$

$$T = \sum_i x_i T_i^{sat} = x_1 T_1^{sat} + x_2 T_2^{sat} + x_3 T_3^{sat} + x_4 T_4^{sat}$$

$$T = 98.28^\circ\text{C}$$

$$\log P_i^{sat} = A_i - \frac{B_i}{T + C_i}$$

$$P_1^{sat} = 402.4583 \quad P_2^{sat} = 1600.311 \quad P_3^{sat} = 714.4188 \quad P_4^{sat} = 1435.393$$

$$\ln \gamma_i = 1 - \ln \sum_j x_j \Lambda_{i,j} - \sum_k \frac{x_k \Lambda_{ki}}{\sum_j x_j \Lambda_{kj}}$$

$$\Lambda_{ij} = \frac{V_j}{V_i} \exp \frac{-a_{ij}}{RT}$$

$$a_{1,2} = -130.6527 \quad a_{2,1} = 101.6588 \quad a_{3,1} = 403.1564 \quad a_{4,1} = -464.1529$$

$$a_{1,3} = 2.0311 \quad a_{2,3} = 198.1757 \quad a_{3,2} = 466.1059 \quad a_{4,2} = 28.8790$$

$$a_{1,4} = 1749.9343 \quad a_{2,4} = 198.1757 \quad a_{3,2} = 466.1059 \quad a_{4,2} = 28.879$$

$$a_{i,j} = 0 \text{ (for } i = j \text{)}$$

(1) Acetic acid: $V_{c1} = 179.7 \text{ cm}^3 / \text{mol}$; $Z_{c1} = 0.211$; $T_{c1} = 592 \text{ K}$

(2) Ethanol: $V_{c2} = 167.0 \text{ cm}^3 / \text{mol}$; $Z_{c2} = 0.240$; $T_{c2} = 513.9 \text{ K}$

(3) Water: $V_{c1} = 55.9 \text{ cm}^3 / \text{mol}$; $Z_{c1} = 0.229$; $T_{c1} = 647.1 \text{ K}$

(4) Ethyl acetate: $V_{c1} = 286.0 \text{ cm}^3 / \text{mol}$; $Z_{c1} = 0.255$; $T_{c1} = 523.3 \text{ K}$

$$V^{sat} = V_c Z_c \left(1 - \frac{T}{T_c}\right)^{0.2857}$$

$$T = 98.28$$

$$V_1 = 55.5768 \quad V_2 = 62.1010 \quad V_3 = 17.6089 \quad V_4 = 109.5433$$

$$\Lambda_{1,1} = 1 \quad \Lambda_{1,2} = 1.1656 \quad \Lambda_{1,3} = 0.3166 \quad \Lambda_{1,4} = 1.1183$$

$$\Lambda_{2,1} = 0.8659 \quad \Lambda_{2,2} = 1.009447632 \quad \Lambda_{2,3} = 0.2659 \quad \Lambda_{2,4} = 1.606$$

$$\Lambda_{3,1} = 2.7698 \quad \Lambda_{3,2} = 3.0325 \quad \Lambda_{3,3} = 1 \quad \Lambda_{3,4} = 4.2236$$

$$\Lambda_{4,1} = 0.5896 \quad \Lambda_{4,2} = 0.5616 \quad \Lambda_{4,3} = 0 \quad \Lambda_{4,4} = 1$$

$$\ln \gamma_i = 1 - \ln \sum_j x_j \Lambda_{i,j} - \sum_k \frac{x_k \Lambda_{ki}}{\sum_j x_j \Lambda_{kj}}$$

$$\ln \gamma_1 = -0.00542 \quad \gamma_1 = 0.9945$$

$$\ln \gamma_2 = -0.00908 \quad \gamma_2 = 0.990957$$

$$\ln \gamma_3 = -0.31399 \quad \gamma_3 = 0.730527$$

$$\ln \gamma_4 = 0.167025 \quad \gamma_4 = 0.167025$$

$$P_j^{sat} = \frac{P}{\sum_i (x_i \gamma_i / \Phi_i) (P_i^{sat} / P_j^{sat})}$$

Select Acetic acid as j component from the set (i)

$$P_j^{sat} = 323.347$$



University of Moratuwa, Sri Lanka.
Electronic Theses & Dissertations
www.lib.mrt.ac.lk

Calculate Temperature

$$T = \frac{B_j}{A_j - \ln P_j^{sat}} - C_j \quad T = 92.0349$$

$$\log P_i^{sat} = A_i - \frac{B_i}{T + C_i}$$

$$P_1^{sat} = 323.347 \quad P_2^{sat} = 1280.348 \quad P_3^{sat} = 567.3297 \quad P_4^{sat} = 1198.784$$

$$y_i = \frac{x_i \gamma_i P_i^{sat}}{P}$$

$$y_1 = 0.19042 \quad y_2 = 0.751245 \quad y_3 = 0.054533 \quad y_4 = 0$$

$$T = 92.0349$$

$$\Lambda_{1,1} = 1 \quad \Lambda_{1,2} = 1.1632 \quad \Lambda_{1,3} = 0.3172 \quad \Lambda_{1,4} = 1.1056$$

$$\Lambda_{2,1} = 0.86790 \quad \Lambda_{2,2} = 1 \quad \Lambda_{2,3} = 0.2669 \quad \Lambda_{2,4} = 1.6059$$

$$\Lambda_{3,1} = 2.7582 \quad \Lambda_{3,2} = 3.01034 \quad \Lambda_{3,3} = 1 \quad \Lambda_{3,4} = 4.1803$$

$$\Lambda_{4,1} = 0.5921 \quad \Lambda_{4,2} = 0.5609 \quad \Lambda_{4,3} = 0 \quad \Lambda_{4,4} = 1$$

$$\ln \gamma_i = 1 - \ln \sum_j x_j \Lambda_{i,j} - \sum_k \frac{x_k \Lambda_{ki}}{\sum_j x_j \Lambda_{kj}}$$

$$\ln \gamma_1 = -0.00551 \quad \gamma_1 = 0.9945$$

$$\ln \gamma_2 = -0.00888 \quad \gamma_2 = 0.9911$$

$$\ln \gamma_3 = -0.30934 \quad \gamma_3 = 0.7339$$

$$\ln \gamma_4 = 0.172688 \quad \gamma_4 = 1.1884$$

$$P_j^{sat} = \frac{P}{\sum_i (x_i \gamma_i / \Phi_i) \left(\frac{P_j^{sat}}{P_j^{sat}} \right)}$$

University of Moratuwa, Sri Lanka.
Electronic Theses & Dissertations
www.lib.mrt.ac.lk

Select Acetic acid as j component from the set (i)

$$P_j^{sat} = 324.4535$$

Calculate Temperature

$$T = \frac{B_j}{A_j - \ln P_j^{sat}} - C_j \quad T = 92.13057$$

By Iterating

Calculated through trial and error

Table C.1: Bubble point temperature and vapor composition

Iteration number	Input temperature for Iteration	Y ₁	Y ₂	Y ₃	Y ₄	Output temperature of the Iteration
1	-	0.237007	0.938975	0.055173	0	98.28026
2	98.28026	0.19042	0.751245	0.054533	0	92.0349
3	92.0349	0.191055	0.75402	0.054985	0	92.13057
4	92.13057	0.191045	0.753976	0.054978	0	92.12905
5	92.12905	0.191045	0.753977	0.054978	0	92.12908
6	92.12908	0.191045	0.753977	0.054978	0	92.12908

 University of Moratuwa, Sri Lanka.
Electronic Theses & Dissertations
www.lib.mrt.ac.lk

Solving Algebraic equations

Assume

$$(A_1)_1 = 5000 \quad (A_0)_1 = 100 \quad \Delta t = 1 \text{ min}$$

Condenser holdup 100 moles assumed to be constant throughout the process.

Applying Euler method

$$(A_0)_{t+\Delta t} = \Delta t (V_1 - L_0 - D) + (A_0)_t$$

$$\text{Let us say } V_1 = 90; \quad \frac{L_0}{V_1} = 0.95;$$

$$L_0 = 0.95 \times 90 = 85.5$$

$$D = V_1 - L_0$$

$$D = 90 - 85.5 = 4.5$$

$$(x_{0,i})_{t+\Delta t} = (x_{0,i})_t + \frac{\Delta t V_1}{A_0} (y_{1,i} - x_{0,i}) + \Delta t R_{0,i}$$

$$(x_{0,i})_2 = (x_{0,i})_1 + \frac{\Delta t V_1}{A_0} (y_{1,i} - x_{0,i}) + \Delta t R_{0,i}$$

$$R = \frac{\rho \sum x_i}{(\sum x_i M_i)} (K_f x_1 x_2 - K_r x_3 x_4)$$

Where $K_f = 4.76 \times 10^{-4} \text{ litre / gmol.min}$ (Mujtaba and Macchietto, 1997).

$K_r = 1.63 \times 10^{-4} \text{ litre / gmol.min}$ (Mujtaba and Macchietto, 1997).

$M_1 = 60.05 \quad M_2 = 46.068 \quad M_3 = 18.015 \quad M_4 = 88.105$

$$R = \frac{10^3 \times (4.76 \times 10^{-4} \times 0.45 \times 0.45 - 1.63 \times 10^{-4} \times 0.1 \times 0)}{(0.45 \times 60.05 + 0.45 \times 46.068 + 0.1 \times 18.01528 + 0 \times 88.105)} = 0.00195$$

$$\Delta H_r = -14.5 \text{ kJ / mol} \text{ (Glessler et al., 2001)}$$



University of Moratuwa, Sri Lanka.
Electronic Theses & Dissertations
www.lib.mrt.ac.lk

Calculation of Condenser composition at t=1minute

$$(x_{0,1})_2 = 0.45 + 0.9 \times (0.191045 - 0.45) + 0.0019 = \underline{\underline{0.2150}}$$

$$(x_{0,2})_2 = (x_{0,2})_1 + \frac{\Delta t V_1}{A_0} (y_{1,2} - x_{0,2}) + \Delta t R_{0,2}$$

$$(x_{0,2})_2 = 0.45 + 0.9 \times (0.753977 - 0.45) - 0.00195 = \underline{\underline{0.7216}}$$

$$(x_{0,3})_2 = (x_{0,3})_1 + \frac{\Delta t V_1}{A_0} (y_{1,3} - x_{0,3}) + \Delta t R_{0,3}$$

$$(x_{0,3})_2 = 0.1 + 0.9 \times (0.054978 - 0.1) + 0.0019 = \underline{\underline{0.0614}}$$

$$(x_{0,4})_2 = (x_{0,4})_1 + \frac{\Delta t V_1}{A_0} (y_{1,4} - x_{0,4}) + \Delta t R_{0,4}$$

$$(x_{0,4})_2 = 0.9 \times (0 - 0) + 0.0019 = \underline{\underline{0.0019}}$$

Calculation of reactor composition at t=1minute

$$(x_{1,i})_{t+\Delta t} = (x_{1,i})_t + \frac{\Delta t L_0}{A_1} (x_{0,i} - x_{1,i}) + \frac{\Delta t V_1}{A_1} (x_{1,i} - y_{1,i}) + R_{1,i} \Delta t$$

$$(x_{1,i})_2 = (x_{1,i})_1 + \frac{\Delta t L_0}{A_1} (x_{0,i} - x_{1,i}) + \frac{\Delta t V_1}{A_1} (x_{1,i} - y_{1,i}) + R_{1,i} \Delta t$$

$$(x_{1,1})_2 = (x_{1,1})_1 + \frac{\Delta t L_0}{A_1} (x_{0,1} - x_{1,1}) + \frac{\Delta t V_1}{A_1} (x_{1,1} - y_{1,1}) + R_{1,1} \Delta t$$

$$(x_{1,1})_2 = 0.45 + 85.5 \times 10^{-3} (0.45 - 0.45) + 90 \times 10^{-3} (0.45 - 0.191045) = \underline{\underline{0.4523}}$$

$$(x_{1,2})_2 = (x_{1,2})_1 + \frac{\Delta t L_0}{A_1} (x_{0,2} - x_{1,2}) + \frac{\Delta t V_1}{A_1} (x_{1,2} - y_{1,2}) + R_{1,2} \Delta t$$

$$(x_{1,2})_2 = 0.45 + 90 \times 10^{-3} (0.45 - 0.753977) = \underline{\underline{0.4473}}$$

$$(x_{1,3})_2 = (x_{1,3})_1 + \frac{\Delta t L_0}{A_1} (x_{0,3} - x_{1,3}) + \frac{\Delta t V_1}{A_1} (x_{1,3} - y_{1,3}) + R_{1,3} \Delta t$$

$$(x_{1,3})_2 = 0.1 + 85.5 \times 10^{-3} (0.1 - 0.1) + 90 \times 10^{-3} (0.1 - 0.054978) = \underline{\underline{0.1004}}$$

$$(x_{1,4})_2 = (x_{1,4})_1 + \frac{\Delta t L_0}{A_1} (x_{0,3} - x_{1,3}) + \frac{\Delta t V_1}{A_1} (x_{1,3} - y_{1,3}) + R_{1,3} \Delta t$$

$$(x_{1,4})_2 = 0.9 \times 10^{-2} (0 - 0) = \underline{\underline{0}}$$

Calculation of condenser heat load

$$(H_{L,0})_{t+\Delta t} = (H_{L,0})_t + \frac{\Delta t V_1}{A_0} (H_{V,1} - H_{L,0}) + \Delta t R_0 \Delta H_r - \frac{\Delta t Q_0}{A_0}$$

$$(H_{L,0})_2 = (H_{L,0})_1 + \frac{\Delta t V_1}{A_0} (H_{V,1} - H_{L,0}) + \Delta t R_0 \Delta H_r - \frac{\Delta t Q_0}{A_0}$$

$$H_{L,0}(1) = T_0(1) \times (x_{0,1}(1) \times cp1 + x_{0,2}(1) \times cp2 + x_{0,3}(2) \times cp3 + x_{0,4}(2) \times cp4)$$

$$H_{L,0}(1) = 92.129 \times (0.45 \times 123.1 + 0.45 \times 125.305 + 0.1 \times 75.3759 + 0 \times 170)$$

$$H_{L,0}(1) = \underline{10993J / mol}$$

$$H_{V,1}(t) = y_{1,1}(t) \times cp1 \times T_1(t) + hfg1 \times y_{1,1}(t) + y_{1,2}(t) \times cp2 \times T_1(t) + \dots$$

$$hfg2 \times y_{1,2}(t) + y_{1,3}(t) \times cp3 \times T_1(t) + hfg3 \times y_{1,3}(t) + y_{1,4}(t) \times cp4 \times T_1(t) + hfg4 \times y_{1,4}(t)$$

$$H_{V,1}(1) = 92.129 \times (0.1910 \times 123.1 + 0.7539 \times 125.305 + 0.054978 \times 75.3759 + 0 \times 170) + \dots$$

$$(24140 \times .1910 + 39388 \times 0.7539 + 0.0549 \times 40715 + 31940 \times 0)$$

$$H_{V,1}(1) = \underline{47805J / mol}$$

$$T_0(2) = 84.1866 \quad x_{01}(2) = 0.215 \quad x_{02}(2) = 0.7217 \quad x_{03}(2) = 0.0614 \quad x_{04}(2) = 0.0019$$

$$H_{L,0}(2) = T_0(2) \times (x_{0,1}(2) \times cp1 + x_{0,2}(2) \times cp2 + x_{0,3}(2) \times cp3 + x_{0,4}(2) \times cp4)$$

$$H_{L,0}(2) = \underline{10259J / mol}$$

$$T_1(2) = 92.3066 \quad x_{11}(2) = 0.4527 \quad x_{12}(2) = 0.4426 \quad x_{13}(2) = 0.1028 \quad x_{14}(2) = 0.0019$$

$$Q_0(t) = \frac{A_0(t)(H_{L,0}(t) - H_{L,0}(t + \Delta t))}{\Delta t} + V_1((H_{V,1}(t) - H_{L,0}(t))) + A_0(t) \times R_0(t) \times \Delta H_r$$

$$Q_0(1) = \frac{100 \times (10993 - 10259)}{1} + 90 \times (47805 - 10259) + 100 \times 0.00195 \times 14500$$

$$Q_0(1) = \underline{3455367J / min}$$



University of Moratuwa, Sri Lanka.
Electronic Theses & Dissertations
www.lib.mrt.ac.lk

Calculation of reactor heat load

$$(H_{L,1})_{t+\Delta t} = (H_{L,1})_t + \frac{\Delta t Q_1}{A_1} - \frac{\Delta t L_0}{A_1} (H_{L,1} - H_{L,0}) - \frac{\Delta t V_1}{A_1} (H_{V,1} - H_{L,1}) + \Delta t R_1 \Delta H_r$$

$$(H_{L,1})_2 = (H_{L,1})_1 + \frac{\Delta t Q_1}{A_1} - \frac{\Delta t L_0}{A_1} (H_{L,1} - H_{L,0}) - \frac{\Delta t V_1}{A_1} (H_{V,1} - H_{L,1}) + \Delta t R_1 \Delta H_r$$

$$H_{L,1}(t) = T_1(t) \times (x_{1,1}(t) \times cp1 + x_{1,2}(t) \times cp2 + x_{1,3}(t) \times cp3 + x_{1,4}(t) \times cp4)$$

$$H_{L,1}(1) = T_1(1) \times (x_{1,1}(1) \times cp1 + x_{1,2}(1) \times cp2 + x_{1,3}(1) \times cp3 + x_{1,4}(1) \times cp4)$$

$$H_{L,1}(1) = 92.129 \times (0.45 \times 123.1 + 0.45 \times 125.305 + 0.1 \times 75.3759 + 0 \times 170)$$

$$H_{L,1}(1) = \underline{\underline{10993 J / mol}}$$

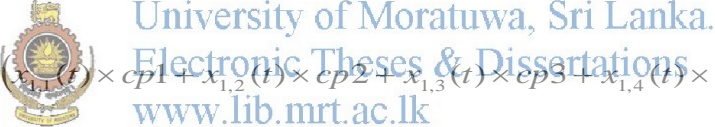

$$H_{L,1}(t) = T_1(t) \times (x_{1,1}(t) \times cp1 + x_{1,2}(t) \times cp2 + x_{1,3}(t) \times cp3 + x_{1,4}(t) \times cp4)$$

$$H_{L,1}(2) = T_1(2) \times (x_{1,1}(2) \times cp1 + x_{1,2}(2) \times cp2 + x_{1,3}(2) \times cp3 + x_{1,4}(2) \times cp4)$$

$$H_{L,1}(2) = 92.3066 \times (0.4527 \times 123.1 + 0.4426 \times 125.305 + 0.1028 \times 75.3759 + 0.0019 \times 170)$$

$$H_{L,1}(2) = \underline{\underline{11008 J / mol}}$$

$$Q_1(t) = \frac{A_1(t)(H_{L,1}(t + \Delta t) - H_{L,1}(t))}{\Delta t} + L_0(H_{L,1}(t) - H_{L,0}(t)) + V_1(H_{V,1}(t) - H_{L,1}(t)) + A_1(t) \times R_1(t) \times \Delta H_r$$

$$Q_1(1) = \frac{A_1(1)(H_{L,1}(2) - H_{L,1}(1))}{\Delta t} + L_0(H_{L,1}(1) - H_{L,0}(1)) + V_1(H_{V,1}(1) - H_{L,1}(1)) + A_1(t) \times R_1(t) \times \Delta H_r$$

$$Q_1(1) = \frac{5000 \times (11008 - 10993)}{1} + 85.5 \times (10993 - 10993) + 90 \times (47805 - 10993) + 5000 \times 0.00195 \times 1450$$

Appendix D:

M file for solving algebraic equations in reactive distillation modeling

```
% This M file simulates batch reactive distillation column for acetic acid
esterification
Reflux=19; %Reflux can be specified
R=Reflux;
V1=90; %V1 can be specified
L0OverV1=0.95;
L0=V1*L0OverV1;
D=L0/R;
A1(1)=5000; % initial molar holdup of reactor
A0(1)=100; % A0 can be specified initial molar hold up of condenser
% 1-Acetic acid 2-Ethanol 3-Water 4-Ethyl Acetate
x01(1)=0.45;x02(1)=0.45;x03(1)=0.1;x04(1)=0; % xoi can be specified,molar
fraction of condenser
x11(1)=0.45;x12(1)=0.45;x13(1)=0.1;x14(1)=0; % molar fraction of reactor

i=1:4;
M(i)=[60.05 46.068 18.01528 88.105]; % Molecular mass of substances
kf=4.76*10^-4;
kr=1.63*10^-4; % rate constants

cp1=123.1;cp2=125.3050;cp3=75.3759;cp4=170; %specific heat capacity J/mol.K
hfg1=24140;hfg2=39388;hfg3=40715;hfg4=31940; % latent heat of vaporization
J/mol
deltaH=14500; %heat of reaction, J/mol

delT=1; % step size
totaltime=1050;

ap(1)=0;
qt=0;

for t=1:delT:totaltime % time interval,min

rho=1000; % density

R0(t)=rho*(x01(t)+x02(t)+x03(t)+x04(t))*(kf*x01(t)*x02(t)-
kr*x03(t)*x04(t))/(x01(t)*M(1)+x02(t)*M(2)+x03(t)*M(3)+x04(t)*M(4)); % rate
of reaction,condenser

R1(t)=rho*(x11(t)+x12(t)+x13(t)+x14(t))*(kf*x11(t)*x12(t)-
kr*x13(t)*x14(t))/(x11(t)*M(1)+x12(t)*M(2)+x13(t)*M(3)+x14(t)*M(4)); %rate
of reaction boiler

a=[x11(t) x12(t) x13(t) x14(t)];% molar fraction of components in reactor
[T1(t) y11(t) y12(t) y13(t) y14(t)]=bubble_point(760,a);

b=[x01(t) x02(t) x03(t) x04(t)];% molar fraction of components in condenser
[T0(t) y01(t) y02(t) y03(t) y04(t)]=bubble_point(760,b);%calls bubble point
function
```



```

A0(t+delT)=A0(t)+delT*(V1-L0-D);% molar holdup of condenser at time=t+delT
min

A1(t+delT)=A1(t)+delT*(L0-V1);% molar holdup of reboiler at time=t+delT min

x01(t+delT)=x01(t)+delT*V1*(y11(t)-x01(t))/A0(t)-delT*R0(t);
x02(t+delT)=x02(t)+delT*V1*(y12(t)-x02(t))/A0(t)-delT*R0(t);
x03(t+delT)=x03(t)+delT*V1*(y13(t)-x03(t))/A0(t)+delT*R0(t);
x04(t+delT)=x04(t)+delT*V1*(y14(t)-x04(t))/A0(t)+delT*R0(t);

x11(t+delT)=x11(t)+delT*L0*(x01(t)-x11(t))/A1(t)+delT*V1*(x11(t)-
y11(t))/A1(t)-delT*R1(t);
x12(t+delT)=x12(t)+delT*L0*(x02(t)-x12(t))/A1(t)+delT*V1*(x12(t)-
y12(t))/A1(t)-delT*R1(t);
x13(t+delT)=x13(t)+delT*L0*(x03(t)-x13(t))/A1(t)+delT*V1*(x13(t)-
y13(t))/A1(t)+delT*R1(t);
x14(t+delT)=x14(t)+delT*L0*(x04(t)-x14(t))/A1(t)+delT*V1*(x14(t)-
y14(t))/A1(t)+delT*R1(t);

ap(t+delT)=ap(t)+x04(t);% average product mole fraction
AP(t)=D*ap(t);%total product moles
totaldis(t)=5100-A1(t)-A0(t);%accumilated total distillate
EApercentage(t)=AP(t)*100./totaldis(t);%percentage of distillate in the
product

end

for t=1:totaltime-1
HL0(t)=T0(t)*(x01(t)*cp1+x02(t)*cp2+x03(t)*cp3+x04(t)*cp4);% molar enthalpy
of L0 flow, J/mole
HL0(t+delT)=T0(t+delT)*(x01(t+delT)*cp1+x02(t+delT)*cp2+x03(t+delT)*cp3+x04
(t+delT)*cp4);
HL1(t)=T1(t)*(x11(t)*cp1+x12(t)*cp2+x13(t)*cp3+x14(t)*cp4);% molar enthalpy
of reactor, J/mole
HL1(t+delT)=T1(t+delT)*(x11(t+delT)*cp1+x12(t+delT)*cp2+x13(t+delT)*cp3+x14
(t+delT)*cp4);

HV1(t)=y11(t)*cp1*T1(t)+hfg1*y11(t)+y12(t)*cp2*T1(t)+hfg2*y12(t)+y13(t)*cp3
*T1(t)+hfg3*y13(t)+y14(t)*cp4*T1(t)+hfg4*y14(t);% molar enthalpy of V1
flow, J/mole;
Q0(t)=A0(t)/delT*(HL0(t)-HL0(t+delT))+V1*(HV1(t)-
HL0(t))+A0(t)*R0(t)*deltaH;% condenser heat duty J/min
Q1(t)=A1(t)/delT*(HL1(t+delT)-HL1(t))+L0*(HL1(t)-HL0(t))+V1*(HV1(t)-
HL1(t))-A1(t)*R1(t)*deltaH;% Reboiler heat duty J/min

qt=qt+Q1(t);%total heat load of reactor J
end

Qt=qt/1000%total heat load reactor
Tb=(totaltime-1)/60%batch time
productionrate=AP(totaltime)/Tb%production rate moles/hr

```



University of Moratuwa, Sri Lanka.
Electronic Theses & Dissertations
www.lib.mrt.ac.lk

Appendix E:

M file to calculate bubble point temperature

```
function [T,y5,y6,y7,y8]=bubble_point(P,x)
%bubble point function calculates bubble point temperature
%and vapor phase composition , Input arguments
%(1)Acetic acid (2)Ethanol (3)Water (4)Ethyl acetate and PmmHg
%Output arguments bubble point temperature and vapor phase composition

i=1:4;
A(i)=[7.5596 8.20417 8.07131 7.2597];%Anotnie constants
B(i)=[1644.05 1642.89 1730.63 1369.41];
C(i)=[233.524 230.3 233.426 235.5];
y2(i)=[0 0 0 0];

Tsat(i)=B(i)./(A(i)-log10(P))-C(i); %Anotnie equation
Tapprox=sum(x(i).*Tsat(i));
Psat(i)=10.^(A(i)-(B(i)./(Tapprox+C(i))));

%Calculation of activity coefficient

% Calculating molar volumes
Vc(i)=[179.7 167 55.9 286];% Critical volume
Zc(i)=[0.211 0.24 0.229 0.255];%Critical Compressibility factor
Tc(i)=[592 513.9 647.1 523.3];%Critical temperature
Vsat(i)=Vc(i).*(Zc(i).^(1-(Tapprox+273.13)./Tc(i)).^0.2857));
m=1:4;n=1:4;
a(m,n)=[1 -130.6527 2.0311 17.992343 11.006588 288.2011;403.1564
466.1059 1 1195.672 464.1529 28.8790 26981.1 1];
for m=1:4
for n=1:4
G(m,n)=(Vsat(n).*(exp(-a(m,n)./(8.314*(Tapprox+273.13)))))./Vsat(m);
end
end
for i=1:4
activity(i)=exp(1-log(x(1)*G(i,1)+x(2)*G(i,2)+x(3)*G(i,3)+x(4)*G(i,4))-
(x(1)*G(1,i)/(x(1)*G(1,1)+x(2)*G(1,2)+x(3)*G(1,3)+x(4)*G(1,4))-
(x(2)*G(2,i)/(x(1)*G(2,1)+x(2)*G(2,2)+x(3)*G(2,3)+x(4)*G(2,4))-
(x(3)*G(3,i)/(x(1)*G(3,1)+x(2)*G(3,2)+x(3)*G(3,3)+x(4)*G(3,4))-
(x(4)*G(4,i)/(x(1)*G(4,1)+x(2)*G(4,2)+x(3)*G(4,3)+x(4)*G(4,4))));
end
i=1:4;
Pjsat=P*Psat(1)/sum(x(i).*activity(i).*Psat(i));
Temp1=B(1)./(A(1)-log10(Pjsat))-C(1);
Plsat(i)=10.^(A(i)-(B(i)./(Temp1+C(i))));
i=1:4;
y1(i)=x(i).*activity(i).*Plsat(i)./P;

Error_tolerance=0.0001;
old_guess=Tapprox;
new_guess=Temp1;

while abs(new_guess-old_guess)>Error_tolerance

old_guess=new_guess;
Temp1=old_guess;

Vsat2(i)=Vc(i).*(Zc(i).^(1-(Temp1+273.13)./Tc(i)).^0.2857));
```

```

for m=1:4
for n=1:4
G2(m,n)=(Vsat2(n).*(exp(-a(m,n)./(8.314*(Temp1+273.13)))))./Vsat2(m);
end
end
for i=1:4
activity2(i)=exp(1-
log(x(1)*G2(i,1)+x(2)*G2(i,2)+x(3)*G2(i,3)+x(4)*G2(i,4))-
(x(1)*G2(1,i)/(x(1)*G2(1,1)+x(2)*G2(1,2)+x(3)*G2(1,3)+x(4)*G2(1,4)))-
(x(2)*G2(2,i)/(x(1)*G2(2,1)+x(2)*G2(2,2)+x(3)*G2(2,3)+x(4)*G2(2,4)))-
(x(3)*G2(3,i)/(x(1)*G2(3,1)+x(2)*G2(3,2)+x(3)*G2(3,3)+x(4)*G2(3,4)))-
(x(4)*G2(4,i)/(x(1)*G2(4,1)+x(2)*G2(4,2)+x(3)*G2(4,3)+x(4)*G2(4,4)));
end
i=1:4;
P2jsat=P*P1sat(1)/sum(x(i).*activity2(i).*P1sat(i));
Temp2=B(1)./(A(1)-log10(P2jsat))-C(1);
P2sat(i)=10.^(A(i)-(B(i)./(Temp2+C(i))));
i=1:4;
y2(i)=x(i).*activity2(i).*P2sat(i)./P;

new_guess=Temp2;
end

T=new_guess;
y5=y2(1);
y6=y2(2);
y7=y2(3);
y8=y2(4);

```



University of Moratuwa, Sri Lanka.
Electronic Theses & Dissertations
www.lib.mrt.ac.lk

Appendix F

M file for heterogeneous catalyst

```
% This M file simulates batch reactive distillation column for acetic acid
% esterification with heterogeneous catalyst
Reflux=19; %Reflux can be specified
R=Reflux;
V1=90; %V1 can be specified
L0OverV1=0.95;
L0=V1*L0OverV1;
D=L0/R;
A1(1)=5000; % initial molar holdup of reactor
A0(1)=100; % A0 can be specified initial molar hold up of condenser
% 1-Acetic acid 2-Ethanol 3-Water 4-Ethyl Acetate
x01(1)=0.5;x02(1)=0.5;x03(1)=0;x04(1)=0; % xoi can be specified,molar
fraction of condenser
x11(1)=0.45;x12(1)=0.45;x13(1)=0.1;x14(1)=0; % molar fraction of reactor

i=1:4;
M(i)=[60.05 46.068 18.01528 88.105]; % Molecular mass of substances
k=5.0*10^-4;
kw=3.2*10^-2;
ke=1.3*10^-1; % rate constants

cp1=123.1;cp2=125.3050;cp3=75.3759;cp4=170; %specific heat capacity J/mol.K
hfg1=24140;hfg2=39388;hfg3=40715;hfg4=31940; % latent heat of vaporization
J/mol
deltaH=14500; %heat of reaction, J/mol

deltT=1; % size, minutes
totaltime=1050; % minutes

ap(1)=0;
qt=0;

for t=1:deltT:totaltime % time interval,min

rho=1000; % density

R0(t)=rho^2*265.28*k*(x01(t)*x02(t) -
(x03(t)*x04(t)/1.907))/((x01(t)*M(1)+x02(t)*M(2)+x03(t)*M(3)+x04(t)*M(4))^2
+kw*x03(t)*rho+ke*x02(t)*rho)^2;% rate of reaction,condenser

R1(t)=rho^2*13264*k*(x11(t)*x12(t) -
(x13(t)*x14(t)/1.907))/((x11(t)*M(1)+x12(t)*M(2)+x13(t)*M(3)+x14(t)*M(4))^2
+kw*x13(t)*rho+ke*x12(t)*rho)^2;%rate of reaction boiler

a=[x11(t) x12(t) x13(t) x14(t)];% molar fraction of components in reactor
[T1(t) y11(t) y12(t) y13(t) y14(t)]=bubble_point(760,a);

b=[x01(t) x02(t) x03(t) x04(t)];% molar fraction of components in condenser
[T0(t) y01(t) y02(t) y03(t) y04(t)]=bubble_point(760,b);%calls bubble point
function

A0(t+deltT)=A0(t)+deltT*(V1-L0-D);% molar holdup of condenser at time=t+deltT
min
```



University of Moratuwa, Sri Lanka.
Electronic Theses & Dissertations
www.lib.mrt.ac.lk

```
A1(t+delT)=A1(t)+delT*(L0-V1);% molar holdup of reboiler at time=t+delT min
```

```
x01(t+delT)=x01(t)+delT*V1*(y11(t)-x01(t))/A0(t)-delT*R0(t)/A0(t);
x02(t+delT)=x02(t)+delT*V1*(y12(t)-x02(t))/A0(t)-delT*R0(t)/A0(t);
x03(t+delT)=x03(t)+delT*V1*(y13(t)-x03(t))/A0(t)+delT*R0(t)/A0(t);
x04(t+delT)=x04(t)+delT*V1*(y14(t)-x04(t))/A0(t)+delT*R0(t)/A0(t);
```

```
x11(t+delT)=x11(t)+delT*L0*(x01(t)-x11(t))/A1(t)+delT*V1*(x11(t)-
y11(t))/A1(t)-delT*R1(t)/A1(t);
x12(t+delT)=x12(t)+delT*L0*(x02(t)-x12(t))/A1(t)+delT*V1*(x12(t)-
y12(t))/A1(t)-delT*R1(t)/A1(t);
x13(t+delT)=x13(t)+delT*L0*(x03(t)-x13(t))/A1(t)+delT*V1*(x13(t)-
y13(t))/A1(t)+delT*R1(t)/A1(t);
x14(t+delT)=x14(t)+delT*L0*(x04(t)-x14(t))/A1(t)+delT*V1*(x14(t)-
y14(t))/A1(t)+delT*R1(t)/A1(t);
```

```
ap(t+delT)=ap(t)+x04(t);% average product mole fraction
AP(t)=D*ap(t);%total product moles
totaldis(t)=5100-A1(t)-A0(t);%accumilated total distillate
EApercentage(t)=AP(t)*100./totaldis(t);%percentage of distillate in the
product
Conversion(t)=(50-A0(t). *x01(t))/50;
end
```

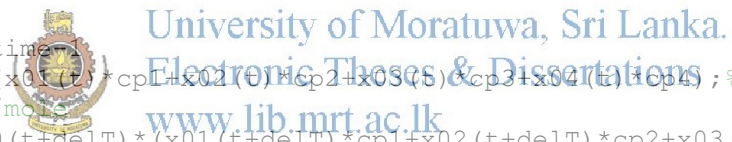

```
for t=1:totaltime
HL0(t)=T0(t)*(x01(t)*cp1+x02(t)*cp2+x03(t)*cp3+x04(t)*cp4);% molar enthalpy
of L0 flow, J/mole
HL0(t+delT)=T0(t+delT)*(x01(t+delT)*cp1+x02(t+delT)*cp2+x03(t+delT)*cp3+x04
(t+delT)*cp4);
HL1(t)=T1(t)*(x11(t)*cp1+x12(t)*cp2+x13(t)*cp3+x14(t)*cp4);% molar enthalpy
of reactor, J/mole
HL1(t+delT)=T1(t+delT)*(x11(t+delT)*cp1+x12(t+delT)*cp2+x13(t+delT)*cp3+x14
(t+delT)*cp4);

HV1(t)=y11(t)*cp1*T1(t)+hfg1*y11(t)+y12(t)*cp2*T1(t)+hfg2*y12(t)+y13(t)*cp3
*T1(t)+hfg3*y13(t)+y14(t)*cp4*T1(t)+hfg4*y14(t);% molar enthalpy of V1
flow, J/mole;
Q0(t)=A0(t)/delT*(HL0(t)-HL0(t+delT))+V1*(HV1(t)-
HL0(t))+A0(t)*R0(t)*deltaH; % condenser heat duty J/min
Q1(t)=A1(t)/delT*(HL1(t+delT)-HL1(t))+L0*(HL1(t)-HL0(t))+V1*(HV1(t)-
HL1(t))-A1(t)*R1(t)*deltaH; % Reboiler heat duty J/min

qt=qt+Q1(t);%total heat load of reactor J
end
```

```
Qt=qt/1000 %total heat load reactor
Tb=(totaltime-1)/60 %batch time
productionrate=AP(totaltime)/Tb %production rate moles/hr
```