

**FAULT LOCALIZATION AND RESTORATION OF
DISTRIBUTION NETWORK USING A MULTI AGENT
BASED SYSTEM**

Aruna Ireshan Panagoda

(108860A)

Thesis submitted in partial fulfilment of the requirement for the Degree of
Master of Science

Department of Electrical Engineering

University of Moratuwa

Sri Lanka

April 2015

Declaration

“I declare that this is my own work and this thesis does not incorporate without acknowledgement any material previously submitted for a Degree or Diploma in any other University or institute of higher learning and to the best of my knowledge and belief it does not contain any material previously published or written by another person except where the acknowledgement is made in the text.

Also, I hereby grant to University of Moratuwa the non-exclusive right to reproduce and distribute my thesis, in whole or in part in print, electronic or other medium. I retain the right to use this content in whole or part in future works (such as articles or books).“

.....
Signature of the candidate
(P.A.A.I Panagoda)

.....
Date

The above candidate has carried out research for the Masters Dissertation under my supervision.

.....
Signature of the supervisor
(Dr. K.T.M.U Hemapala)

.....
Date

.....
Signature of the supervisor
(Dr. P.S.N. De Silva)

.....
Date

Abstract

Power distribution network reduces its reliability during the fault localization, isolation and network reconfiguration. High voltage and medium voltage distribution system fault localization process consumes more time and network reconfiguration get complex when there are more interconnections.

Therefore the objective of the research is to provide a methodological approach for the fault restoration problem in power distribution network of Sri Lankan using the de-centralized approach. Agent based solution was implemented with Multi Agent System (MAS) to address above issue and the system is characterized de-centralized nature and easily expandable nature. The system comprises with Application layer, Interface layer and communication layer. The application layer was developed using Java Agent Development Environment (JADE). The interface layer and the communication layer are tie together to confirm physical integration and which enables to use modern communication techniques with the system application.

The MAS based decentralized system can be applied to improve the reliability of Sri Lankan power distribution network.

Dedicated

To my parents

Acknowledgement

I would like to express my heartiest gratitude to my supervisors, Dr. K.T.M.U Hemapala and Dr. P.S.N De Silva for their support, guidance and valuable advices throughout these academic years. I would like to thank University of Moratuwa for giving me the opportunity for my Master studies. I would like to specially thank to Dr. P.S.N De Silva as the Head of Engineering of Lanka Electricity Company (LECO) and the Branch Manager and all staff of LECO Kotte Branch for giving me the support to accomplish my study by providing necessary details on power distribution network.

Finally, thanks to all lecturers & my friends, that I have been working with the throughout the period of study in University of Moratuwa.

TABLE OF CONTENTS

Declaration	i
Abstract	ii
Acknowledgement	iv
List of Figures	vii
List of Tables	ix
List of Abbreviations	x
1. INTRODUCTION	1
1.1. Power Distribution System-Sri Lanka	2
1.2. Distribution System Fault Restoration- Conventional method	5
1.3. Objective and Scope of the research	7
2. MULTI AGENT SYSTEM	8
2.1. Features of Multi Agent System	8
2.2. Multi Agent System in Real World Applications	9
2.3. The Foundation for Intelligent Physical Agents (FIPA)	10
2.3.1. Agent Management	10
2.3.2. Agent Communication	12
2.4. Agent Development Toolkit	15
2.5. Java Agent Development Environment (JADE)	16
2.6. JADE Architecture	17
2.6.1. Agent Communication	18
2.6.2. Agent Behaviour	18
2.6.3. Interaction Protocols	20
2.6.4. Yellow Pages Service	20
2.6.5. Socket Proxy Agent	21
3. LITERATURE REVIEW	22
3.1. Power System Restoration Model	22
3.1.1. Centralized Approach	23
3.1.2. Common drawbacks of Centralized approach	24
3.1.3. Multi Agent Approach on Power System Restoration	25
4. SYSTEM IMPLEMENTATION	27
4.1. Conceptual design	27
4.1.1. Physical System	27

4.1.2.	Communication Layer	30
4.1.3.	MAS Application Layer	30
4.2.	Agent Conceptualization in Physical system	31
4.2.1.	Primary Substation- PSS Agent	31
4.2.2.	Feeder Agent	33
4.2.3.	Load Break Switch – LBS Agent	33
4.3.	Multi Agent System Main Processes	33
4.3.1.	System Data Update	36
4.3.2.	Fault Localization Process	37
4.3.3.	Fault Isolation	40
4.3.4.	Network Reconfiguration	41
4.4.	Interface Layer Implementation	46
5.	RESULT AND VALIDATION	49
5.1.	Agent Creation	49
5.2.	Case Study	51
5.3.	Physical System Integration	54
6.	CONCLUSION	56
6.1.	Further Improvements	58
	References	59

LIST OF FIGURES

Figure 1.1: Typical Power System [2]	2
Figure 1.2: Transmission Network Sri Lanka	4
Figure 1.3: Kolonnawa PSS and Feeder Arrangement in LECO Distribution Network	5
Figure 2.1: Agent Management Reference Model	11
Figure 2.2: Agent Lifecycle	12
Figure 2.3: FIPA Message Structure	12
Figure 2.4: FIPA Request Interaction Protocol [33]	14
Figure 2.5: Contract Net Interaction Protocol [34]	15
Figure 2.6: Java Agent Development Environment	16
Figure 2.7: Jade Architecture [37] [38]	17
Figure 2.8: JADE Asynchronous messaging	18
Figure 2.9: Agent Execution cycle [37]	19
Figure 2.10: Behaviour Hierarchy	19
Figure 2.11: Yellow Pages Service [37]	20
Figure 2.12: Proxy agent behaviour	21
Figure 3.1: ABB Smart Compact Secondary Substation solution	24
Figure 3.2: Intercommunication used in [3]	26
Figure 4.1: System modelling	27
Figure 4.2: Kolonnawa PSS Switches arrangement	28
Figure 4.3: Radial distribution feeder	29
Figure 4.4: Communication Layer Abstraction	30
Figure 4.5: Agent Conceptualization	32
Figure 4.6: Flow chart of Main Processes	35
Figure 4.7: System Update Process	36
Figure 4.8: Proxy Message Template	37
Figure 4.9: Fault incident at Radial Feeder	37
Figure 4.10: Fault inform process	38
Figure 4.11: Localizing Fault Upstream LBS	39
Figure 4.12: Fault Isolation Flow Diagram	40
Figure 4.13: Fault Isolation Interaction Protocol	40
Figure 4.14: Network Reconfiguration flow diagram	41
Figure 4.15: Contract-net protocol for evaluation restoration proposals	42

Figure 4.16: Search for available Power	43
Figure 4.17: Communication Pattern in the event of fault	44
Figure 4.18: Network Rearrangement	45
Figure 4.19: Proxy Message Received to Communication Interface	46
Figure 4.20: ACL Message Parsing Flow diagram	48
Figure 5.1: LBS Agent GUI	49
Figure 5.2: JADE Remote Agent Management GUI	49
Figure 5.3: Directory Facilitator GUI	50
Figure 5.4: Communication Layer GUI	50
Figure 5.5: Case Study	51
Figure 5.6: ACL Communication for fault restoration	52
Figure 5.7: Network configuration after the fault restoration of Case	53
Figure 5.8: Demonstration Board Sketch	55
Figure 5.9: Demonstration board in testing environment	55

LIST OF TABLES

Table 1: ACL Message Parameter	13
Table 2: Agent Toolkit Comparison [35]	16
Table 3: Breaker Voltage, Current at a fault	37
Table 4: Elapsed time of execution Results	54

LIST OF ABBREVIATIONS

Abbreviation	Description
ACL	Agent Communication Language
AP	Agent Platform
AR	Auto Re-closer
CEB	Ceylon Electricity Board
DDLO	Drop Down Lift On
FIPA	Foundation for Intelligent Physical Agent
JADE	Java Agent Development Environment
LBS	Load Break Switch
LECO	Lanka Electricity Company
MAS	Multi Agent System
PSS	Primary Substation
SCADA	Supervisory Control and Data Acquisition

1. INTRODUCTION

The national grid comprises with high voltage power transmission lines, which interconnect the power generation and power distribution substations. Typical power system diagram is shown in figure 1.1 and which symbolizes the main icons in a power system, such as power generation, power transmission and power distribution.

The transmission network in Sri Lanka is solely owned by Ceylon Electricity Board (CEB) and it operates at 220kV and 132 kV voltage levels. Transmission line brings the power generated at power stations to the primary substation where it starts the power distribution. The transmission line network in Sri Lanka in 2014 is shown in the figure 1.2 [1] as stated by CEB.

The power distribution network in Sri Lanka is owned by CEB and Lanka Electricity Company (LECO). The scope of a power distribution network is to bring the generated and transmitted power to the consumer premises. Power from primary substation to the end users is distributed via power feeders and there are several number of power feeders started from primary substations. The feeder arrangement of Kolonnawa primary substation owned to LECO Kotte branch area is shown in figure 1.3. There are seven feeders indicated in the figure and the number of feeders is depend on the power requirement of feeding area.

Though the feeder is considered as a circuit, it is a combination of several sections for the better feeder control and management. Power breakers used in power distribution networks are in different types according to their applications eg: Load Break Switch (LBS), Isolator, Sectionalizer, Auto Reclosure (AR). There exist interconnections between parallel feeders to provide more alternative routes between them to use during a fault restoration.

The switching arrangement of each feeder is set by the control center of either CEB or LECO. The control center has a greater responsibility to keep the power distribution system reliable.

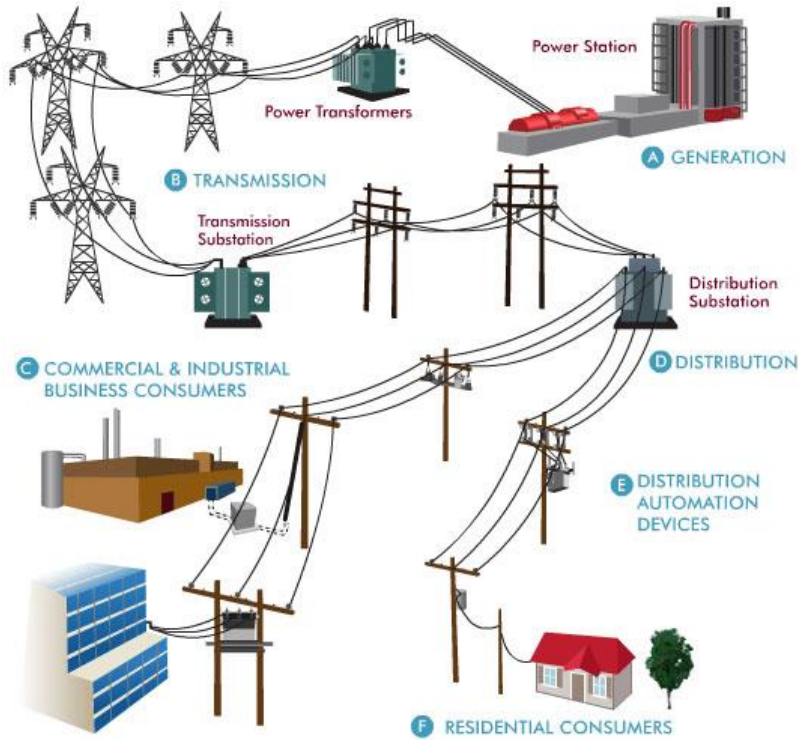

Figure 1.1: Typical Power System [2]

The novelty and modern techniques have been applied in some sections of the distribution system in Sri Lanka, such as automated remote metering, remote breaker operations, etc. But distribution system fault localization and restoration is carried out using conventional technologies.

The Supervisory Control and Data Acquisition Systems (SCADA) are heavily used in small scale and fixed scoped power systems in all over the world and various vendors offer more robust SCADA systems. The national power distribution system keep updating year by year. Therefore the automated control system should be capable of keep updating and address the more complex problem solving ability in future. The SCADA systems are focused on centralized, fixed scope solutions. Hence distribution system based SCADAs needed to be upgraded to match with expanded physical system.

1.1. Power Distribution System-Sri Lanka

In Sri Lanka, the starting point of the power distribution network is the primary substation and there are large number of primary substations located all over the country. From a primary substation, the power is distributed via feeders and they run over the area normally for 20-30 kilometres. Each feeder consists of several number of load break switches. The main duty of the

load break switch is to break the load during it is loaded. Hence this device is not capable on activating upon the faults automatically.

However the technology of the load break switch is far developed; its remote operating capability is developed. Therefore modern control centers can rearrange the radial distribution system from a central place according to the operational requirements.

The feeder protections are set at circuit breaker level of primary substations. But in some locations the auto re-closers are installed at primary substation for the immediate fault restorations. Feeder protection covers the overcurrent, short time over current, earth fault, shot time earth faults. During any of such fault occurred at the remote location of the distribution feeder, it get tripped off from the primary substation breaker, bringing the darkness to the entire area.

In the conventional system operated in Sri Lanka there are several ways and steps to localize, isolate the fault and re-arrange the network.

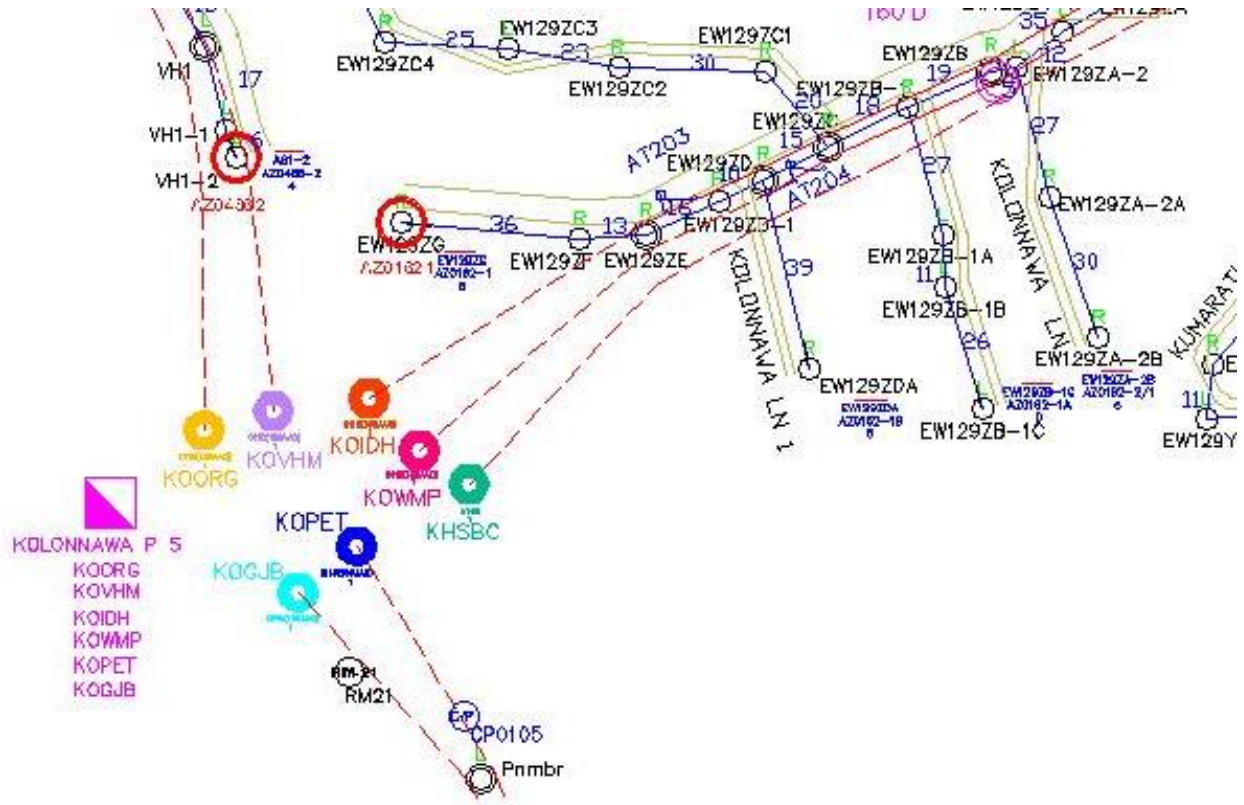

Figure 1.3: Kolonnawa PSS and Feeder Arrangement in LECO Distribution Network

1.2. Distribution System Fault Restoration- Conventional method

When a fault occurs at distribution system, it gets tripped off the particular feeder from the primary substation bringing darkness to the entire area. These faults can be divided as High Voltage (HV) faults and low voltage (LV) faults.

The electricity is an essential commodity for every Srilankan. Therefore in every power breakdown, power consumers complain about the breakdown to the control center or the area offices. Most of the times these information comes with some clues for the fault localization. Based on the fault details received from the power consumers, maintenance teams start the fault finding.

LV system faults most of the times end up at the Drop Down Lift On (DDLO) of its feeding transformer. Once this DDLO fuse get replaced; the system getting to operational except at exceptional cases. LV faults will not result to the trip off from the primary substation. Therefore in this study it was researched the behaviour of HV fault and providing a good restoration plan.

When a distribution feeder is connected via an auto-recloser, it can easily classify the persistent faults. If the auto recloser is not installed, the easiest and fastest fault rectification technique is the closing feeder breaker again. Then if the system is not get tripped, the system condition is healthy.

If the system get tripped again, then fault is persist within the system and it is needed to make a restoration plan immediately. There are several ways to localize the faults in the conventional system and most of the times those steps execute in a sequential pattern, if one step is not succeeded then moves to the next step.

1. Based on consumer complains – Power consumers complain with eye witness of the fault event.
2. Prior Experience of the Operation team- Operation team guess from their experience and visited those places directly.
3. Route Inspection- Inspect the HV line whether it is touched with tree leaves or any other fallen things on the HV line. (E.g.: Vehicle accidents damaging the HV line).
4. Energize the feeder- Feeder is energize section by section starting from Primary end isolating other sections. This helps to find out faulty section.
5. Finer fault finding- This method started if it did not find any noticeable fault found on the high tension line. This step is executed by climbing to the every HV pole of the faulty section.

Above fault finding methods are ordered with respect to the time taken to localize the fault. In a particular incident if it is needed to go for the fifth method; then it would take days to localize the fault.

Therefore if it is needed to go for the fifth item, the normal practice is to isolate the particular section and energize the maximum number of sections by rearranging the network. In the restoration plan, it is needed to take the support of another feeder on the same primary or different. In such a situation control center of CEB or LECO analyses the best option by comparing the past data and informs operational teams the rearrangement plan. Then the operational team activates the new arrangement and bring the un-energized areas into operational.

The conventional fault finding method is very inefficient and it consumes more time and money. Therefore it has been researched many solutions to address this issue on how to restore the power

system efficiently in all over the world. In most power systems, it is deployed the Supervisory Control and Data Acquisition (SCADA) system and this provide good solution with centrally data processing. The modern SCADA systems monitor and control the power systems as well as it has linked with billing and accounting as well.

But when the scope of the power system is getting larger and area of control getting bigger, the SCADA system starts facing the problems of its inter communication and flexibility on expanding the system. The power distribution network in Sri Lanka has spread very largely and it keeps updating yearly. So when it comes, how to intercommunicate devices such as primary substation, load break switches, etc with a centrally controlled system is a huge capital cost. Therefore centrally control topology for the distribution system is not a cost effective approach due to above constraints.

Therefore instead of giving centrally controlled topology for the restoration problem in a distribution system, it is more effectively to handle this problem with decentralize topology. In other words, if the country has more control centers it makes easier for the communication and problem optimization. But the system flexibility problem persist there as unresolved.

1.3. Objective and Scope of the research

The objectives of the research are,

- To provide a new technological approach to fault localizing and restoration which match with operating context in Sri Lanka.
- To develop an automated system, which can be easily extensible and can be interface with other smart grid technologies.

Therefore this research is to design, develop and simulate a multi agent system that enable to localize the distribution system fault, restore the system for the maximum supply reliability.

2. MULTI AGENT SYSTEM

Technology develops day by day to provide best approach for the complex problems. Decentralized approach and Centralized approach are two main stream debated today. Each of above stream has its advantages and disadvantages.

Multi Agent System (MAS) is simply developed based on the one important component named as agent and the system comprises of more than one agent is named as the multi agent system. There are various definitions for the multi agent system.

In [3], the MAS is defined as a system with component level intelligence. Those intelligent components are named as an agent and the system with a group of agents is named as a MAS.

In [4], the agent is introduced as a software entity exist in some environment having sense on the changes and ability to react on them autonomously and goal directed manner. In a multi agent system, tasks are carried out by interacting agents that can cooperate with each other.

2.1. Features of Multi Agent System

The agent is the most important concept of the multi agent system and agent is defined as a software component having special features to bring its autonomy. With its special features agent can act as a human agent and it helps to model complex system and introduce the possibility of having common or conflicting goals. The agent comprises with the main special features of autonomous, social, reactive and proactive [5].

Autonomous- Agent can act without direct intervention of human or other factor and it can control its actions over the initial state.

Social- Agents are corporate with human or other agents to achieve the common complex goal.

Reactive- Agent perceives the environment changes and act over them in timely fashion.

Proactive- Agent is not simply act on the environment and it is able to exhibit goal directed behaviour by taking initiative.

In addition to above main features agents can have the ability to travel between different nodes in a computer network, which shows its mobility. Agent is truthful as it providing the certainty that

it will not deliberately communicate false information. Agent is always acting to achieve the goals and never to prevent goals, and it can learn from its environment.

2.2. Multi Agent System in Real World Applications

Multi Agent system is widely used in variety of application areas from small industrial application to space related activities.

The core areas where the featured advantages of multi agent system used are process control, system diagnosis, manufacturing, transport logistics and network management.

In process control systems, the study in [6] describes the application of MAS corporate with conventional hierarchical process control to provide advantages of both techniques. In the study [7] reveals the application of features of Agents; goal oriented behaviour and social behaviour for the corporation control in process control. In [8], it describes about energy infrastructure control. Energy control and management system has parameter inputs from surrounding environment, indoor comfort related parameter and system constraints for optimum energy consumption and finally system provide better control.

In the fault diagnosis process in complex systems, MAS plays an important role as it can employ intelligent agents at different levels to monitor the process. The reliability of the complex software has to be ensured with software testing methodologies and effectively fault localizing, classifying of fault events using MAS is described in [9]. Online diagnosis and online conditioning monitoring in power system is in [10]. The fault diagnosis in power system is time consuming job with available data volume and analytical device inputs. The automation the system with available data volume is addressed in [11]. The multi agent based health care diagnosis system is new research area over the traditional medical diagnosis systems [12], [13]. The fault diagnosis in electronic devices [14] and the diagnosis in internet business [15] are new areas where MAS deployed.

In manufacture control it has to tackle the temporal dynamics, uncertainty, information sharing, coordination and corporation. These challenges are addressed and resolved in numerous manufacture controls by employing MAS [16], [17], [18], [19].

Transport and Logistic is very unpredictable and rising demanded area where the broad and fine attention required. Most conventional technologies face lots of challenges when it comes to the

automation. The MAS has addressed these issues with the inherent features of agent and multi agent system [20], [21], [22], [23], [24], [25].

In network management; the conventional technologies becoming inadequate to solve the scalable, flexible and economic solution and these challenges has addressed using MAS [26], [27], [28]. The network security agent application can employ its intelligence on reasoning, goal directed behaviour, corporation and communication; which helps to reach the specified goal [29]. In Wide Area Network, the intelligent agent capable of diagnose hardware failures, network traffic and solve the problems locally by social interactions [30].

2.3. The Foundation for Intelligent Physical Agents (FIPA)

The Foundation for Intelligent Physical Agents (FIPA) is the body to set the full standard for the agents and agent based systems.

The FIPA was established as an international non-profit institution to develop collection of standards. FIPA is the IEEE officially accepted standards organization for agent and multi agent system. The standards can be viewed in different categories such that agent communication, agent management, agent transport, agent architecture and application. Some of the core categories are discussed in below section.

2.3.1. Agent Management

The Agent Management comprises several entities as illustrated in the Figure 2.1; Agent, Agent Management System, Directory Facilitator and Message Transport System [31].

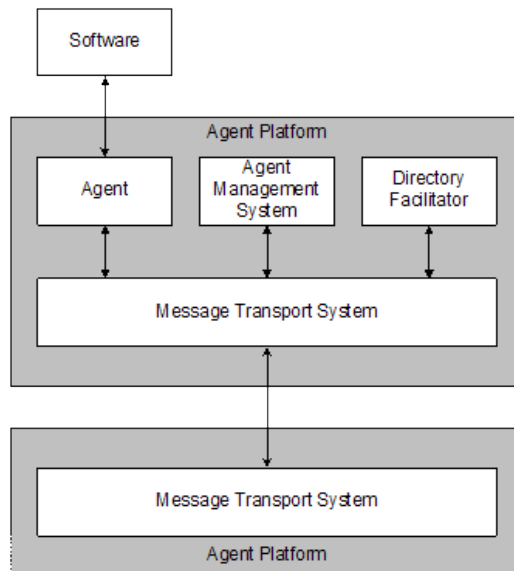

Figure 2.1: Agent Management Reference Model

Agent- Agent is a computer process entity having autonomous and communication ability. Agent is the main actor of an agent platform.

Agent Management System (AMS) – AMS is a mandatory element of an agent platform and there is only one agent platform in an agent platform. AMS maintains the details of the agent in the agent platform. AMS is responsible for the managing the agent in the AP such as agent creating, agent deleting, agent migration, etc. The life cycle of the agent is managed by the agent management system and the lifecycle status are illustrated in the figure 2.2.

In the life cycle; when agent at active state Message Transport System (MTS) deliver the messages to agent as normal and at the initiated, waiting or suspended state, MTS buffers the messages until the agent become active. The transit state is for the mobility agent and MTS buffer the messages with it until the move get finished or it forward them if the forward function has set to another location.

Directory Facilitator (DF) – This is an optional component in agent platform and if DF present it provides the yellow page service to the agent. So it allow agent to register their services and agent to search the services among other agents.

Message Transport System (MTS) – This is the default communication between agents on different agent platforms

Agent Platform (AP) – This is the physical infrastructure for agent deployment.

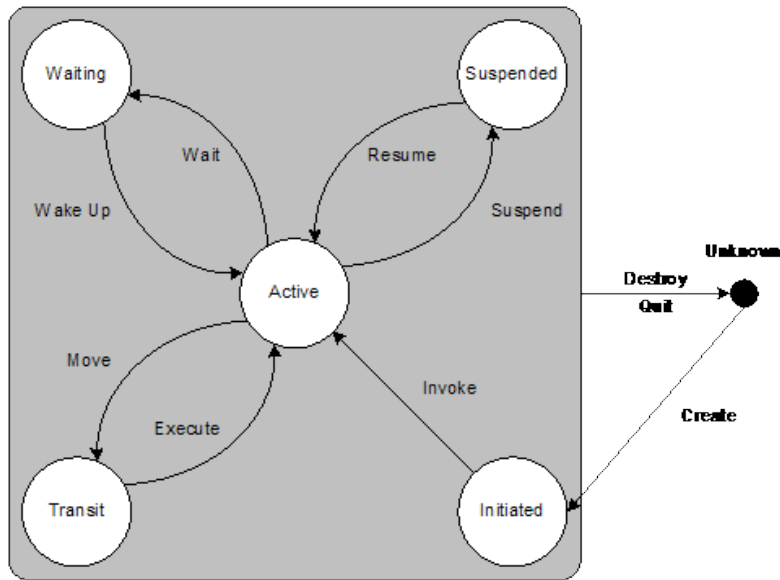

Figure 2.2: Agent Lifecycle

2.3.2. Agent Communication

FIPA agent communication deals with agent communication language, message exchange Interaction Protocol and Content Language representations.

FIPA Agent Communication Language (ACL) defines one or more parameter to make the communication effective. Though parameter “*Performative*” is the mandatory parameter, usually ACL message contains the sender, receiver and message contents [32].

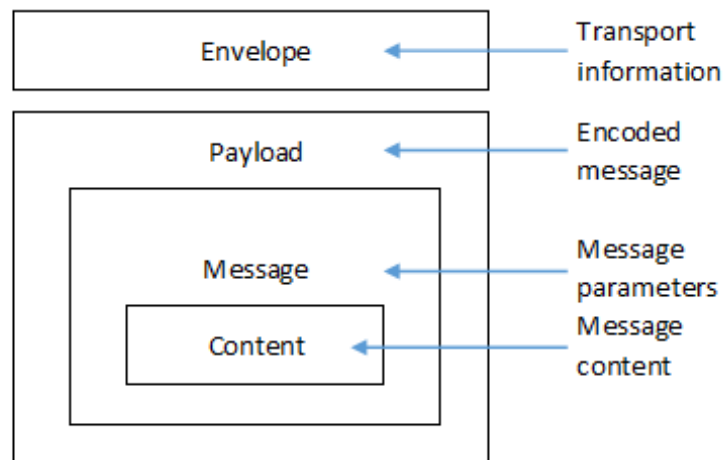

Figure 2.3: FIPA Message Structure

ACL message parameter and its description is illustrated in the table 1.

Parameter	Category of Parameter
performative	Type of communicative acts of the message
sender	Identity of the sender of the message
receiver	Identity of the intended recipients of the message
reply-to	Which agent to direct subsequent messages to within a conversation thread
content	Content of the message
language	Language in which the content parameter is expressed
encoding	Specific encoding of the message content
ontology	Refer to an ontology to give meaning to symbols in the message content
protocol	Interaction protocol used to structure a conversation
conversation-id	Unique identity of a conversation thread
reply-with	An expression to be used by a responding agent to identify the message
in-reply-to	Reference to an earlier action to which the message is a reply
reply-by	A time/date indicating by when a reply should be received

Table 1: ACL Message Parameter

The simple ACL message with request performative is given below [5],

```
(request
  :sender (agent-identifier :name alice@mydomain.com)
  :receiver (agent-identifier :name bob@yourdomain.com)
  :Ontology travel-assistant
  :language FIPA-SL
  :protocol fipa-request
  :content
    ""((action
      (agent-identifier :name bob@yourdomain.com)
      (book-hotel :arrival 15/10/2006
                  :departure 05/07/2002 .....))
    )
)
```

The Interaction Protocols (IP) deals with pre-agreed message exchange protocols. The request protocol and contract net protocol are described here as they are heavily used at the application developments.

The request interaction protocol is illustrated its protocol steps in figure 2.4. In this protocol one agent request to perform an action from the participants and participant agree or refuse the request. Then agreed agents notify the status after performing action either done or failure [33].

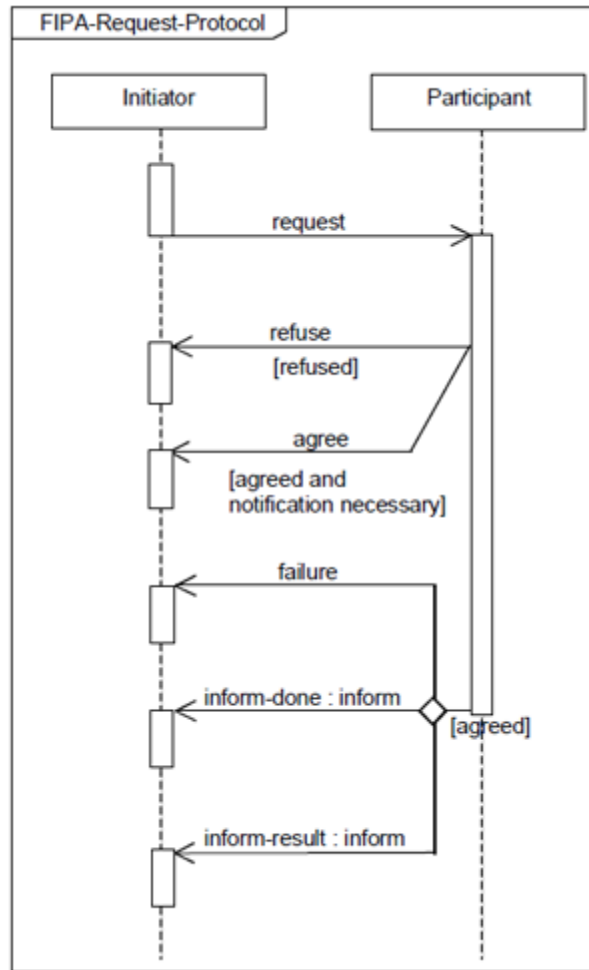

Figure 2.4: FIPA Request Interaction Protocol [33]

Similar to the request interaction protocol, the contract net interaction protocol is initiated the conversation with participant to submit their bids or “call for proposal - CFP” as illustrated by the figure 2.5. The offers from the participant are evaluated by the initiator and select the best option and award the contract to the selected best agent by sending accepted message. Finally the contract awarded agent reply back to initiator either action done or failure [34].

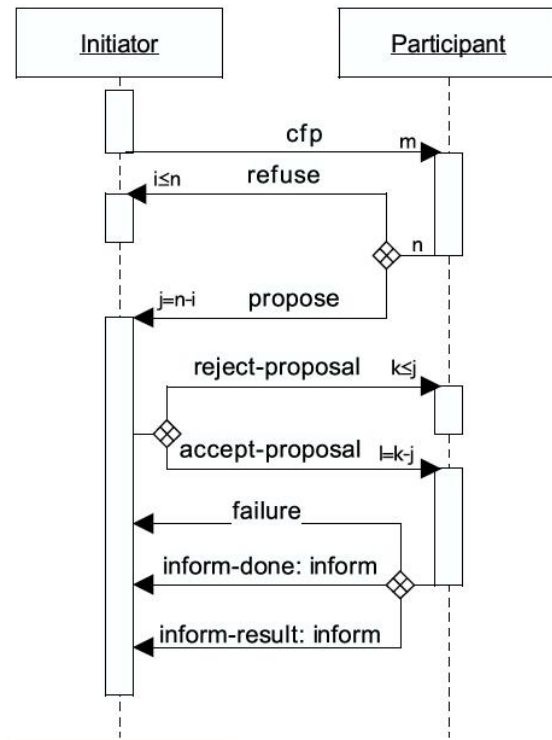

Figure 2.5: Contract Net Interaction Protocol [34]

2.4. Agent Development Toolkit

The infrastructure to develop the agent system as specified in the FIPA standard is named as agent development tool kits. Toolkit provides support for application development, security for communication among agents, facilitation for agent mobility, etc. Present there are several developed agent toolkits such as JADE, Zeus, Aglet and the comparison between each is given in table 2 [35].

	Aglet	Voyager	JADE	Anchor	Zeus
Nature of Produce	Free, Open source	Commercial	Free, Open Source	Available in BSD license	Free, open source
Standard implemented	MASIF	-	FIPA Compliant	SSL, X.509	FIPA compliant
Communication Technique	Synchronous , Asynchronous	All methods	Asynchronous	Asynchronous	Asynchronous
Security Mechanism	Poor	Weak	Good	Strong security	Good
Agent Mobility	Weak	Weak	Not-so-weak	Weak	Do not Support
Agent Migration Mechanism	Socket	RMI	RMI	Socket	Null

Table 2: Agent Toolkit Comparison [35]

From the available toolkits JADE is at the front line.

2.5. Java Agent Development Environment (JADE)

JADE is an agent development framework in compliance with FIPA and which was started by Telecom Italia Lab. JADE is open sourced since 2000 and it is released under the Lesser General Public License (LGPL) [36]. JADE is software platform that provides basic middleware-layer functionalities and jade implements software agent abstraction over a well-known object oriented language JAVA [5]. Therefore MAS application flexibility has been improved by allowing the agent mobility via wired, wireless networks as indicated by the figure 2.6.

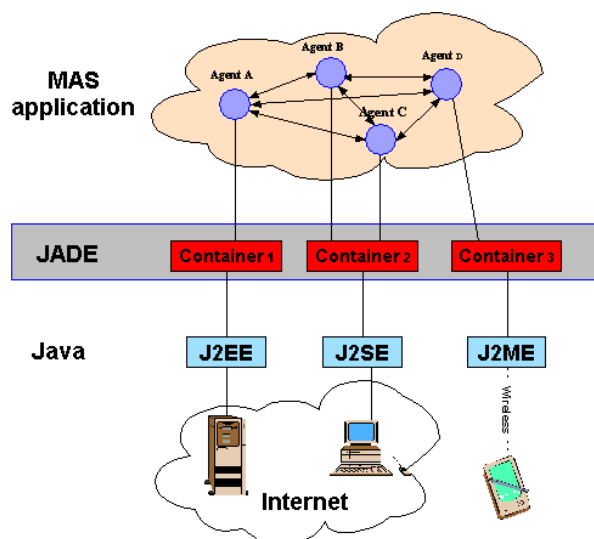

Figure 2.6: Java Agent Development Environment

2.6. JADE Architecture

Jade architecture comprises with several main components as illustrated in figure 2.7. They are;

- Agent
- Container
- Platform
- Main Container
- AMS & DF

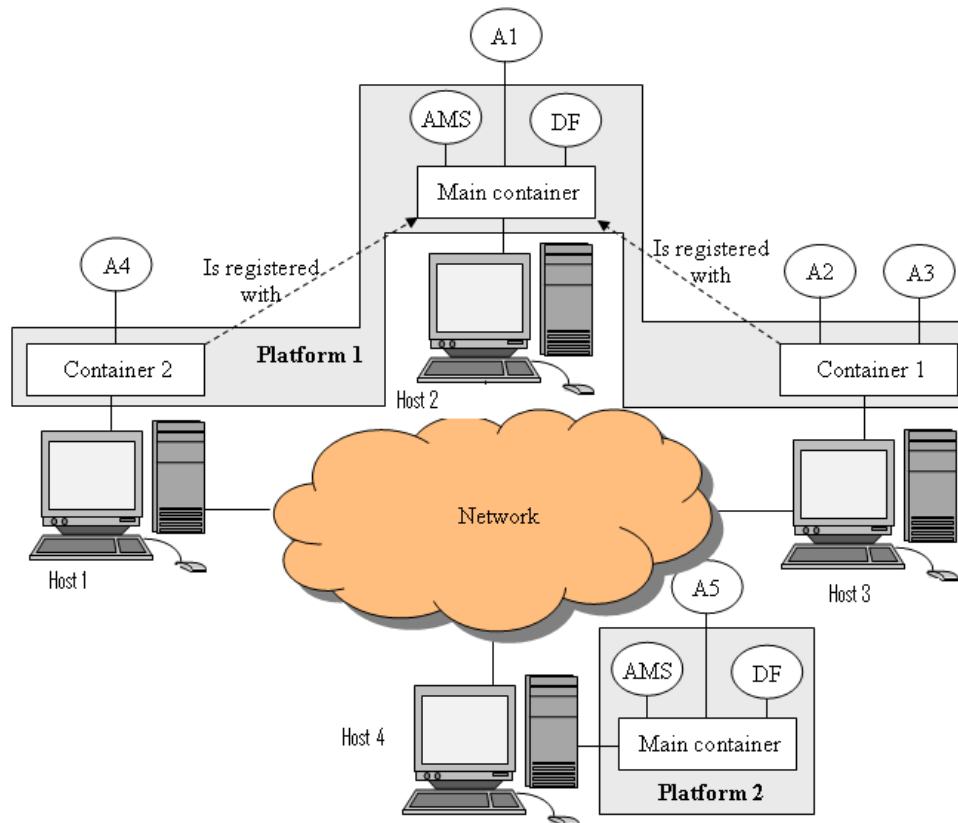

Figure 2.7: Jade Architecture [37] [38]

The agent framework; JADE essentially comprises with set of agents; which are having unique name. Agent is a software entity which execute its task while interacting with other agents exchanging messages. Agent are launched on the platform; which provides all base line infrastructure for the successful birth of agents. In a platform it contains one or more containers and main container is a special one. Containers can be launched at different host in same platform

achieving the distributed ability of the platform [36]. The main container is launched at the time of first starting of the JADE platform. The main container holds important responsibilities of;

- Managing Container Table
- Managing global agent descriptor table (GADT)
- Provide assistance to the agent management system (AMS) and directory facilitator (DF) for their services.

When the main-container is launched the special agent of AMS and DF are automatically launched [5].

2.6.1. Agent Communication

Agents can communicate with other agents regardless of their origin or in other words the container or the platform. Communication is based on the asynchronous message passing and the message format is fully compliant with FIPA as described on 2.3.2. Asynchronous message exchange implemented in JADE is illustrated in figure 2.8.

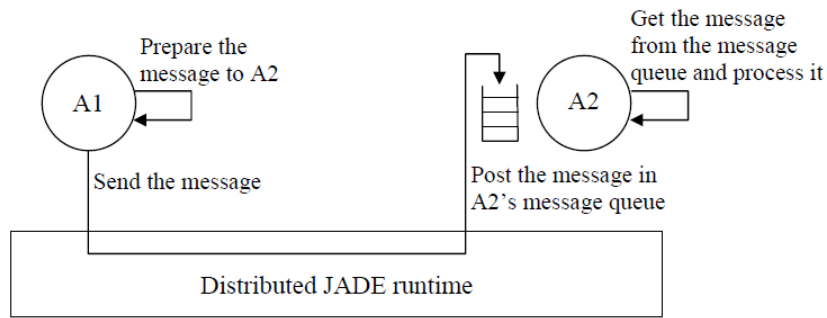

Figure 2.8: JADE Asynchronous messaging

2.6.2. Agent Behaviour

The behaviour represents the task that an agent can carry out; responding to the external events. As illustrated in figure 2.9; the behaviour scheduling is in round robin non pre-emptive manner. Therefore behaviour execution starts one after another and second behaviour starts only after first behaviour complete.

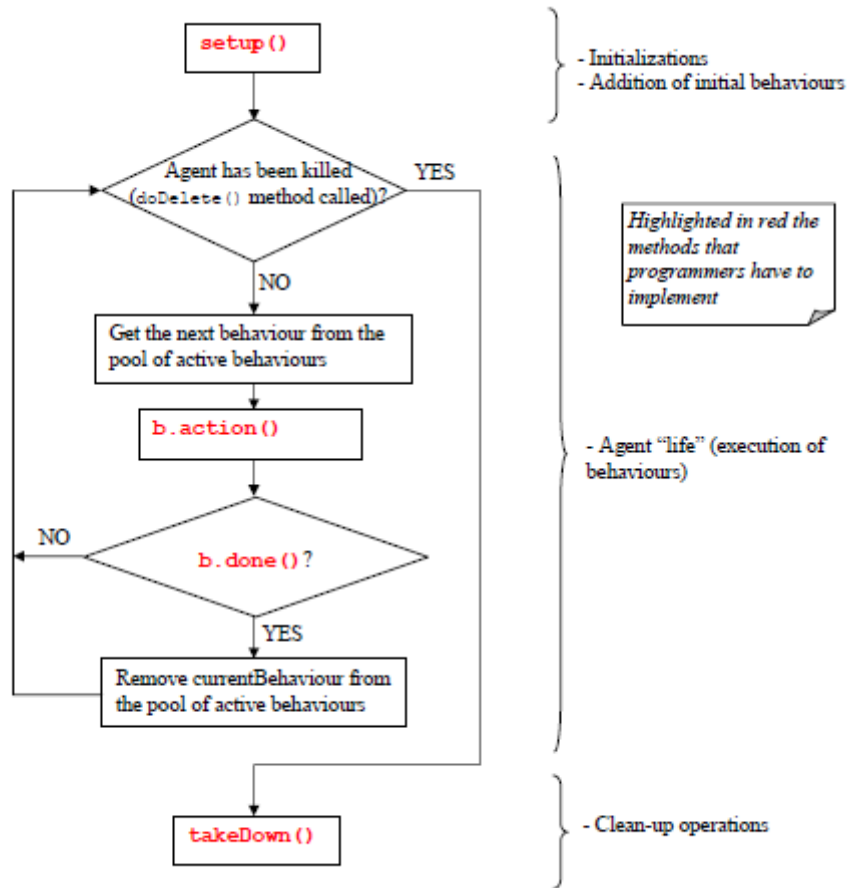

Figure 2.9: Agent Execution cycle [37]

There are exist several behaviour types and the hierarchy of the behaviour class is shown in figure 2.10. This behaviour class allows to schedule the agent tasks as well as manage the state transitions; starting, blocking and restarting.

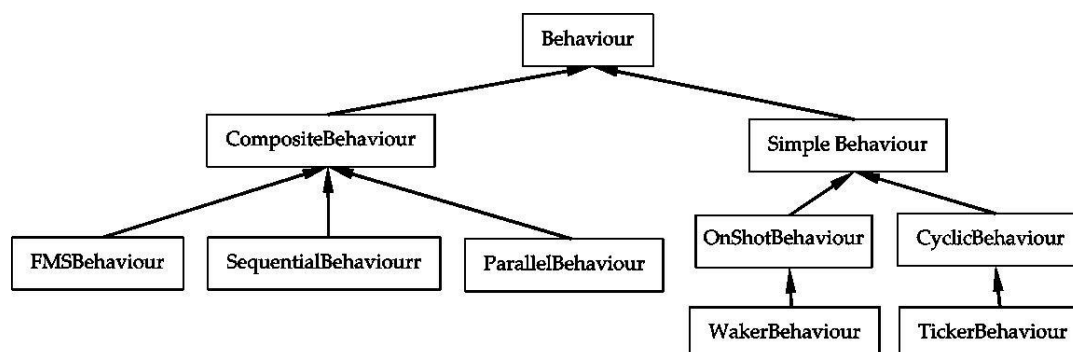

Figure 2.10: Behaviour Hierarchy

The agent behaviour can be blocked either calling block() method or it can be blocked until limited amount of time passing. A blocked behaviour can resume the execution when one of following conditions occurs;

- An ACL message received belongs to the behaviour.
- A timeout period expires.
- The restart() method call.

By having this blocking technique, it allows better agent control while scheduling the multitasking [38].

2.6.3. Interaction Protocols

FIPA specifies set of standards for the interaction protocols as described in section 2.3.2. JADE has created role of initiator (agent starting the conversation) and role of responder (agents engaging the conversation) successfully and all these roles terminated and removed from the task queue once it comes to the final state [38].

2.6.4. Yellow Pages Service

Yellow pages service allows agent to register one or more services and other agent can find successfully the services and use them as illustrated on figure 2.11. The yellow pages service in JADE is implemented using the special agent directory facilitator (DF) which is launched automatically when time of launching of agent platform. There are readily available the methods in JADE for successful agent registration, publishing services and finding services [37].

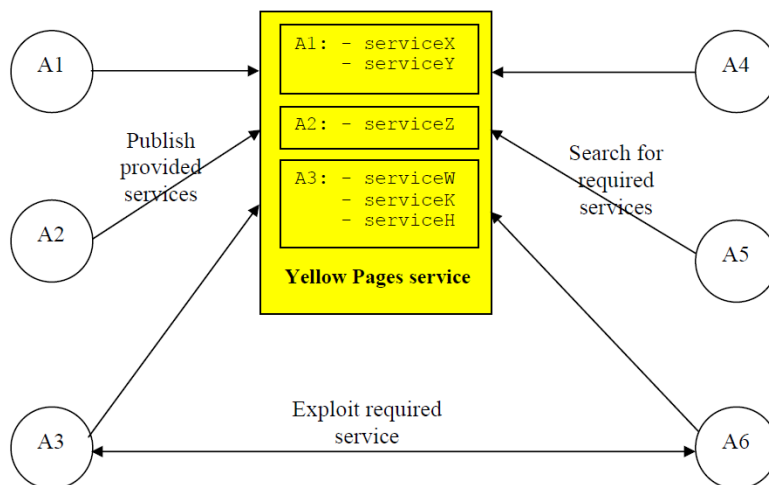

Figure 2.11: Yellow Pages Service [37]

Socket Proxy Agent

This is the agent introduced for the communication with external systems. The socket proxy agent is comes with the jade platform and at the initialization of the socket proxy agent it looks for the <agentname>.inf file where “agentname” is the name given for the socket proxy instance.

In the .inf file it should contain the port number in the first line and the list of agent name that wishes to exchange messages should include at the second line.

The socket proxy agent behave similar to the proxy server that is found in the computer networks; which exchange messages according to the rule given in the file as illustrates in figure 2.12.

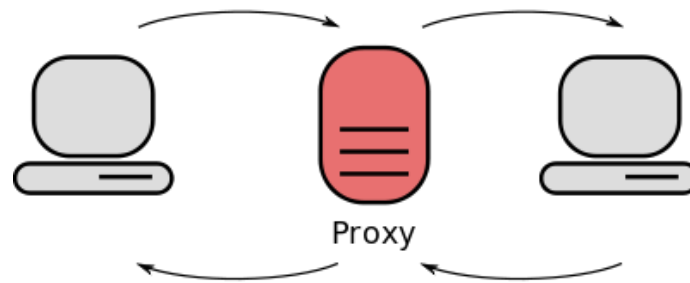

Figure 2.12: Proxy agent behaviour

The socket proxy communication is similar to the client server model and multi agent system act as the server and outside system act as the client.

So when a message arrives to multi agent system through socket proxy agent it parse the incoming message and check for the destination agent against the list given and forward to the destination agent. Each answer from the destination agent is forward back through socket proxy agent.

Here the incoming message to the socket proxy is essentially in the exact way defined by the FIPA described in 2.3.2, unless socket proxy cannot parse the incoming message correctly. The answer from the destination agent is FIPA typed message and outside system need to parse the message to exact details included in it.

Single socket proxy agent has the limitation of handling only 50 numbers of connection. Then this would be a real obstacle when implementing large scale multi agent system. But with the distributed nature of the multi agent system, by adding different hosts this handling capacity can be increased to the required level.

3. LITERATURE REVIEW

There are several approaches to develop multi agent based system to address power distribution system fault isolation and restoration. This chapter reviews the different technological approaches and their importance and the performance.

3.1. Power System Restoration Model

In power distribution system, when a fault occurred it has to be cleared immediately. There were several technological researches to address this problem. During a fault restoration; first the localized fault has to be isolated and then network needed to be reconfigured to energize the network as much as possible to minimize the outage. The distribution network getting more reliable when there are several number of alternative to restore the fault. In a fault restoration model;

Objective function: Maximize the power to the loads as much as possible

$$\max \sum_{i=0}^n Li. yi$$

Where;

L- Load of the de-energized section

y- Decision variable on energized is required or not; 1- restored 0- not restored (applies for load shedding)

Constraints:

1. Generation limits: Total power required should be below the generation capacity

$$\sum_{i=0}^n Pi. xi \leq Gi$$

Where;

P- Power flow of the section

x- Decision variable 1- restored 0- not restored (applies for load shedding)

2. Feeder limit: Power flow at the time of restoration should not exceed the capacity of feeder cable; switches and other components.

$$|P| \leq U$$

Where;

P- Power flow of the feeder section

U- Maximum capacity of the feeder (feeder limit)

3. The proposed reconfiguration should ensure the radial configuration. The total number of feeder incident on the section must be at most unity [3], [39].

In a developed distribution network, it contains more feeder interconnections and which make the feeder management more flexible. So when an event of fault at the feeder, this flexibility provide several alternatives to energize the non-energized areas of the feeder. When finding the best alternative it is considered;

1. Required power capacity vs available power capacity of the feeder
2. Required power flow vs feeder limits.
3. Any other special conditions set out by the control center.

All the available alternatives are ranked according to the above criteria and the best alternative is selected. But there are instances the best alternative cannot restore the power to entire de-energized area. In such a situation, same procedure is to be iterated until the entire area energized or until the last alternative evaluated.

The algorithms are used to resolve above problem can be categorized into two main types according to their approach.

3.1.1. Centralized Approach

There were several studies carried out in the centralized approach to solve the complex distribution network fault restoration problems. Each of study has been used special type of technique to provide an optimum solution. The fuzzy reasoning for network reconfiguration, after the fault localized is proposed in [40]. The fuzzy reasoning is developed to implement the operator's heuristic rules and past experiences. In [41], it present a comparative study of four heuristic method

to restore the power system; reactive tabu search, tabu search, parallel simulated annealing and genetic algorithm and finally compared the effectiveness of each method on restoration solution. Another heuristic studies are presented in [42], [43]. These studies present the heuristic approach usually provides the solution more closely to the operator does.

The genetic algorithm approach is presented in [44], it search for optimal supply restoration strategy subjected to the radial constrain in the distribution system. In [45], it presents power restoration technique base on non-dominated sorting genetic algorithm-II, which contrast to the conventional genetic algorithm and this is much faster than conventional method. The refined genetic algorithm based technique is presented in [46], to improve the time consume to solve the power restoration in distribution system. The combination of fuzzy logic and genetic algorithm is presented in [47]. In this technique the objective function set is evaluation by the fuzzy set and optimization is done by genetic algorithm to make entire process to be efficient. The evolutionary algorithm based technique is presented in [48]. However this consume more time for large scale distribution system.

3.1.2. Common drawbacks of Centralized approach

In a centralized structure the heart of the system is at the control center and the data is fed to the control center for processing.

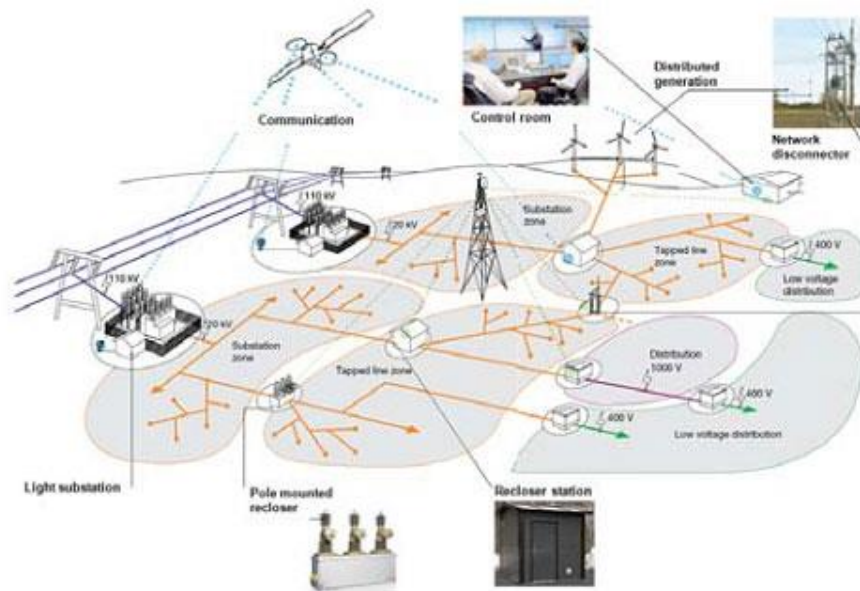

Figure 3.1: ABB Smart Compact Secondary Substation solution

In figure 3.1 it illustrate the centralized control system architecture given in ABB smart power distribution system. Centrally controlled distribution networks are developed for decades. Therefore it has its own advantages as well as its inherent drawbacks.

- The main computer system is expensive since it is with high processing power with big memories.
- System optimization required software with high sophisticated optimization algorithm, hence high initial cost.
- Expensive wired or wireless communication systems needed be used.
- Additional cost on good redundancy system.
- Finally the single point of breakdown can results the entire system failure.

All above drawbacks are due to the centrally processing typed architecture. In decentralized system, contrary to centralized system, it can avoid higher cost on the central point. Most common decentralized architecture applied is the multi agent system architecture. Though at the MAS system can avoid the higher system on the center, it is needed to draw more attention on the inter-communication system.

3.1.3. Multi Agent Approach on Power System Restoration

In [49], it illustrates the values of multi agent system in power engineering field and it further describes the fundamental concepts and approaches in order to solve power engineering problems. This study presents the summary of the multi agent based researches on power engineering field in different subject areas, such as protection, modelling & simulation, distributed control and monitoring & diagnostics.

In [3], it presents the multi agent based approach using JADE. In this approach entire distribution network comprised with three type of autonomous agents; generator agent, switch agent and load agent. Each agent communicate with its neighbouring agent and during a fault using forward communication and backward communication it finds best network arrangement as illustrated in figure 3.2.

The multi agent algorithm has been used for ring structured shipboard power system in [50]. Since this is ring structured power system, it is used the spanning tree based inter communication to

restore the system in the event of a fault. The multi agent based approach to managing the power distribution network including the fault isolation and network reconfiguration is presented in [51].

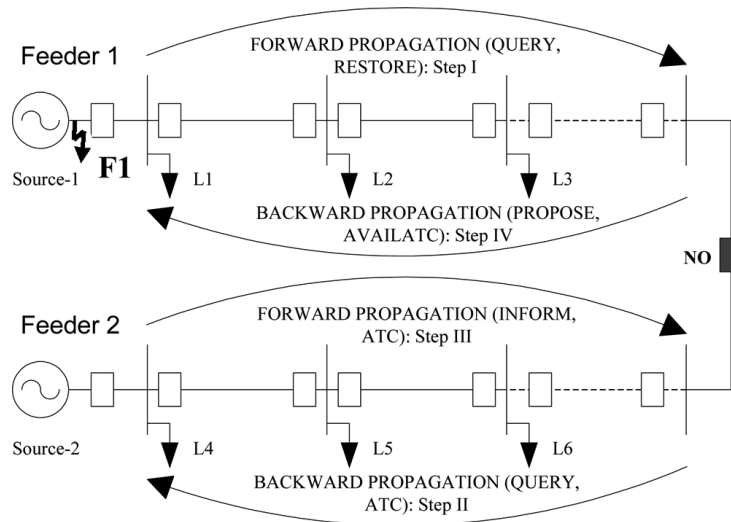

Figure 3.2: Intercommunication used in [3]

In [52] and [39], they are presented the multi agent based algorithm using the two agent types bus agent and junction agent and verify their application for a large scale power system. Multi agent system performance has to evaluate using the simulation studies before real world application.

In [53], it is discussed the multi agent system with power system simulation using Virtual Test Bed (VTB) simulation package. Multi agent based restorative control on urban power network is presented in [54]. In this study, the agents are formed according to the functional requirements such as restorative management agent, data pre-processing agent, reactive power and voltage optimization agent. This strategy is verified for the use on-line control of urban power network.

The presented multi agent approaches on the power distribution system restoration problem, have a common feature of the suitability for any sized power system.

4. SYSTEM IMPLEMENTATION

4.1. Conceptual design

The main components of the multi agent based application is given in the figure 4.1. As illustrated in the figure, the application consist of two layers such as application layer and communication layer. The combination of those two layers create the multi agent system application and it controls the physical system communicating via wired or wireless technology.

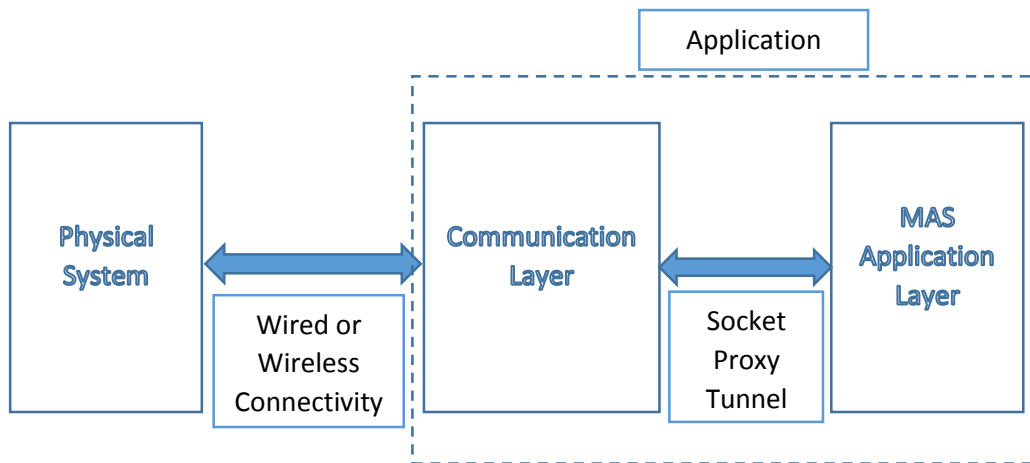

Figure 4.1: System modelling

4.1.1. Physical System

The physical system represent the power distribution network. A typical power distribution network starting from the Kolonnawa primary substation is shown in figure 4.2. In a distribution system it can be seen main components such as, primary substation, distribution feeders, circuit breakers, distribution transformers, metering points, etc. In the Kolonnawa primary substation, there are several feeders starting from there and in each feeders it contains several load break switches.

Primary Substation (PSS)

When the transformer transforms power from high voltage to medium voltage (for the distribution) or from medium voltage to medium voltage; that is termed as primary substation.eg: 132kV to 33kV or 33kV to 11kV. In other words primary substation is the starting point of a power

distribution network and thereby power is distributed to consumer level via distribution system equipment such as load break switches, distribution transformer, etc.

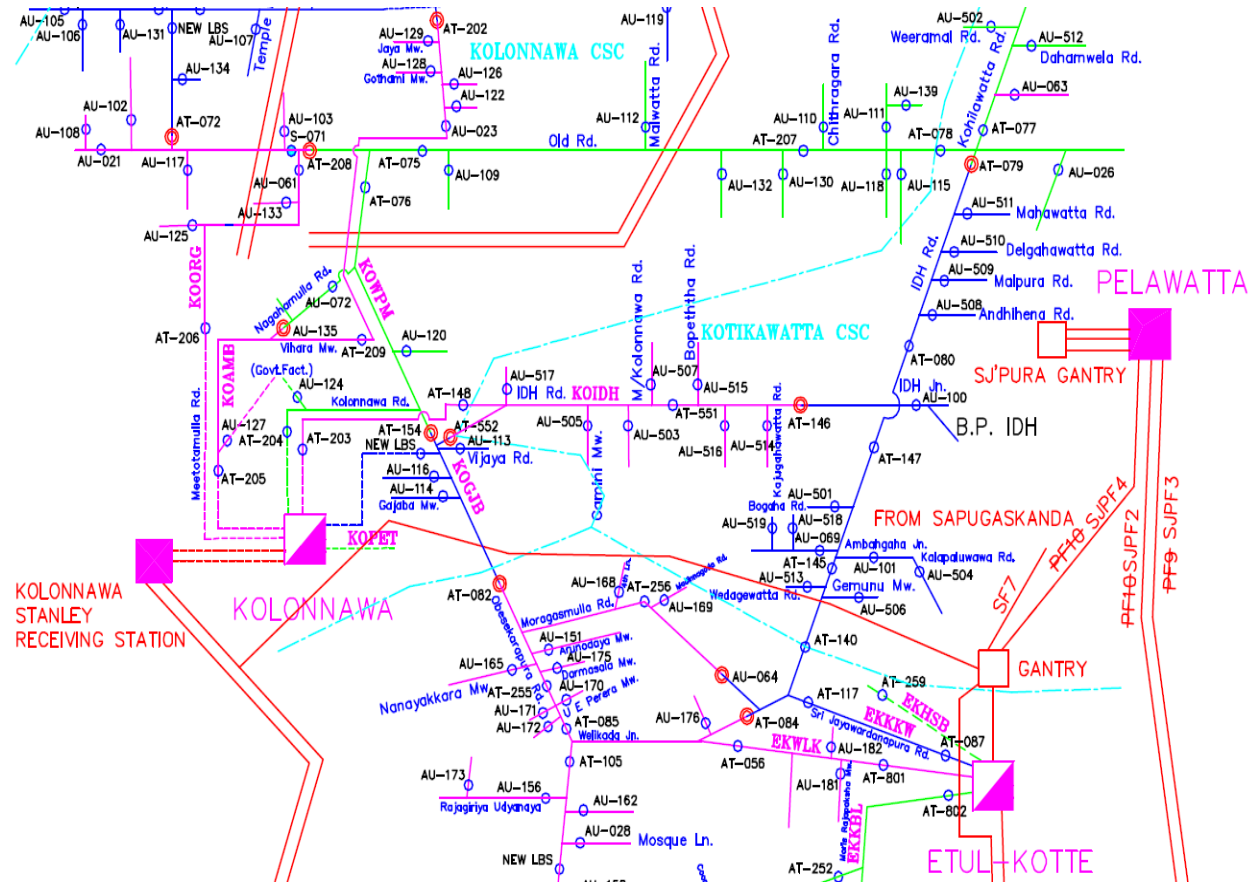

Figure 4.2: Kolonnawa PSS Switches arrangement

Distribution Feeder

The distribution feeder is the connection link between primary substation and distribution substations. Distribution feeders are two types such as radial feeders and ring feeders. Radial feeder is the simpler type of feeder and it is less expensive to implement as it only contain single source. In a ring feeder power flow can be in either direction; hence it is needed to draw more attention on switching configurations. Which results the ring feeder networks to be more expensive and complex compared to radial network. At the same time in a fault in a ring structured distribution system the interrupted section will be minimum as it provides the power from either directions. In this study it is considered on radial power distribution feeder system as shown in figure 4.3.

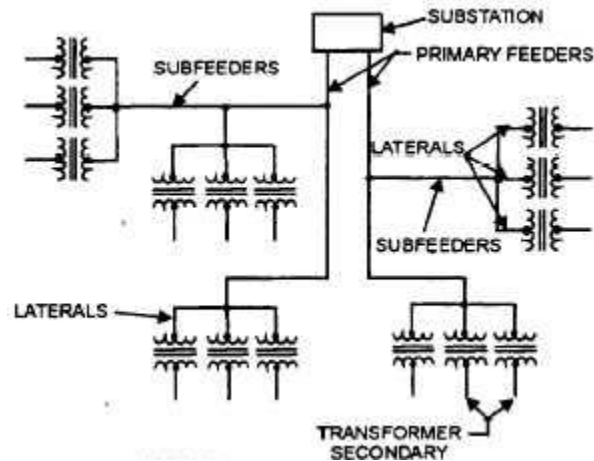

Figure 4.3: Radial distribution feeder

In order to make the radial configured feeders more reliable there establish more interconnections between parallel feeders and in an event of fault interrupted section can be minimized manually configuring the interconnecting switches.

Feeder Switch

There are different kind of feeder switches employed in a power distribution feeders such as feeder isolator, load break switch (LBS), auto reclosure switch (AR).

Feeder isolators, the name implies it is a circuit isolator and advised to operate at no load condition. Unlike the feeder isolators, LBS and AR can be operated when the feeders are energized as it contains special mechanism to break high voltage circuit. The AR equipped with a mechanism to close the opened AR due to a momentary fault and thereby AR improves the system reliability as it filter out the momentary faults.

Today's LBS technology has developed to making them to be controlled and monitored remotely. Distribution system automation become a reality with these remotely controlled LBS and with more advanced wireless techniques.

4.1.2. Communication Layer

The communication layer is the facilitator to communicate effectively between MAS application and physical system. The figure 4.4 graphically describes the duties of the communication layer.

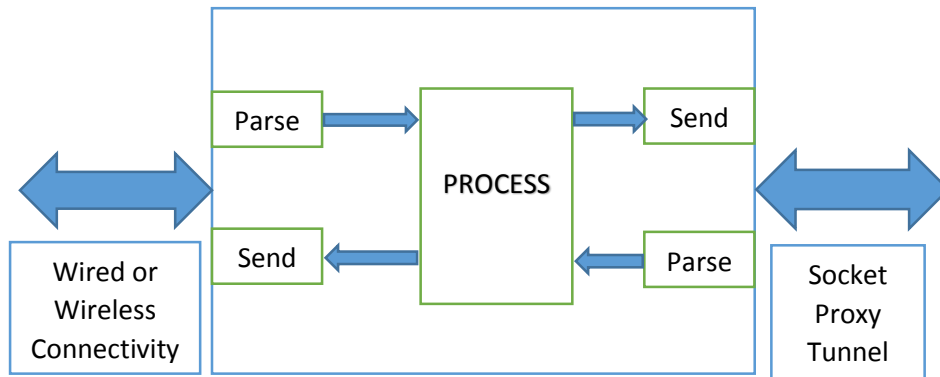

Figure 4.4: Communication Layer Abstraction

For the remote control and monitoring of equipment there are widely used wireless technologies such as IEEE 802.11 based wireless LAN, IEEE 802.16 based WiMAX, 3G/4G cellular, ZigBee based on IEEE 802.15, IEEE 802.20 based MobileFi, etc. The challenges related to the each technology has been discussed in [55]. These communication technologies are applied between physical equipment and its control monitor software. In this study, it is concerned on the communication between these proprietary software and the communication layer.

When it communicate with MAS application, the socket proxy tunnel is used as described in the section 2.6.5. The challenge here is to parse the incoming message from either side of communication and send them in their communication protocol.

In order to achieve this data parsing it is used the technique “*pattern matching regular expression*” in java [56] and in matlab [57]. This technique is further described at section 4.4.

4.1.3. MAS Application Layer

Multi agent system bring the Photostat of physical system and make the distribution system equipment live. Then all equipment coordinate with each other to manage the distribution system autonomously. In the below sections it will illustrate into the depth of the agent types used, their behaviours to achieved desired target.

4.2. Agent Conceptualization in Physical system

In the control point of view the main components in the distribution system in Sri Lanka are primary substation (PSS), Feeder and Load Break Switch. Therefore in order to represent the power distribution system it was selected the agents as Primary Substation Agent, Feeder Agent and Load Break Switch Agent. Typical distribution system with the above mentioned agents types are shown in figure 4.5. Each agent type has its own responsibilities and capabilities.

4.2.1. Primary Substation- PSS Agent

PSS Agent is a top manager of a distribution system and the distribution system is a corporation of PSS agents. Its main responsibilities are as follows,

- Register its details on the Yellow Pages
- Search about LBS agents and feeder Agents from the yellow pages
- Investigate the fault location and localized the fault
- Commanding the Feeder Agent to Provide the Best Proposal for the Fault Restoration

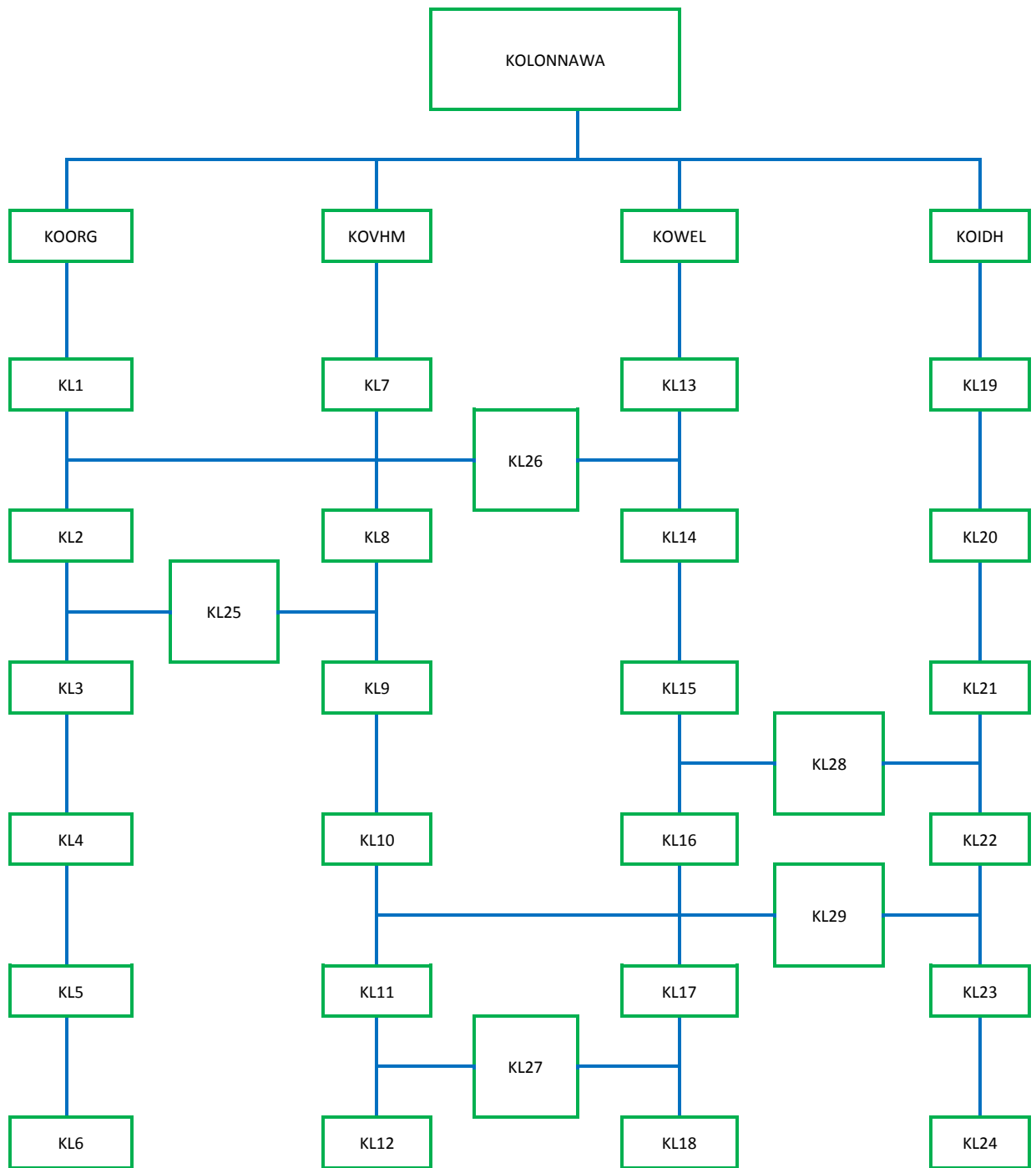

Figure 4.5: Agent Conceptualization

4.2.2. Feeder Agent

The feeder agent is the manager for the LBSs and it reports to the PSS Agent. The main duties of feeder agent are summarized below. As in the physical environment, the feeder is a branch distributed from PSS and it is a group of equipment. Therefore in this study, feeder agent act as a virtual agent.

- Register Details of feeder agent on Yellow Pages
- Search details about LBS and PSS from the yellow pages
- Commanding LBS Agents how to isolating the faults
- Start the discussion with LBS how to restore the fault
- Find out best proposal from available alternatives.
- Giving commands to the LBS for the Network rearrangement

4.2.3. Load Break Switch – LBS Agent

The load break switch (LBS) agent is the last level of this framework and its duties are summaries below,

- Register details on the Yellow Pages
- Find out details of the feeders and primary from the yellow pages
- Keep update its operating current
- When voltage level get loosed, inform the Primary agent about the fault
- Contribute to the discussion for fault localization
- Activate the fault isolating actions according to the feeder agent
- Activate Fault Restoration actions according to the feeder Agent

4.3. Multi Agent System Main Processes

The whole process discussed here is summarised to a flow diagram in figure 4.6 and it points out some main processes assist the system to operate. They are,

1. System Data update
2. Fault Localization
3. Fault Isolation
4. Network Reconfiguration

The physical system sends data messages to the MAS in two instances depending on its voltage level.

The first typed message is initiated when the system voltage at operational level and at periodic time intervals as configured at communication layer. The main objective of this message is to inform the MAS about the system operation condition such as operating current via the load break switch.

The second typed of the message is initiated at the event of voltage loss at the load break switch or voltage goes to zero. In such situation, load break switch is advised to send messages to the relevant agent at MAS, assuming fault has occurred in the system.

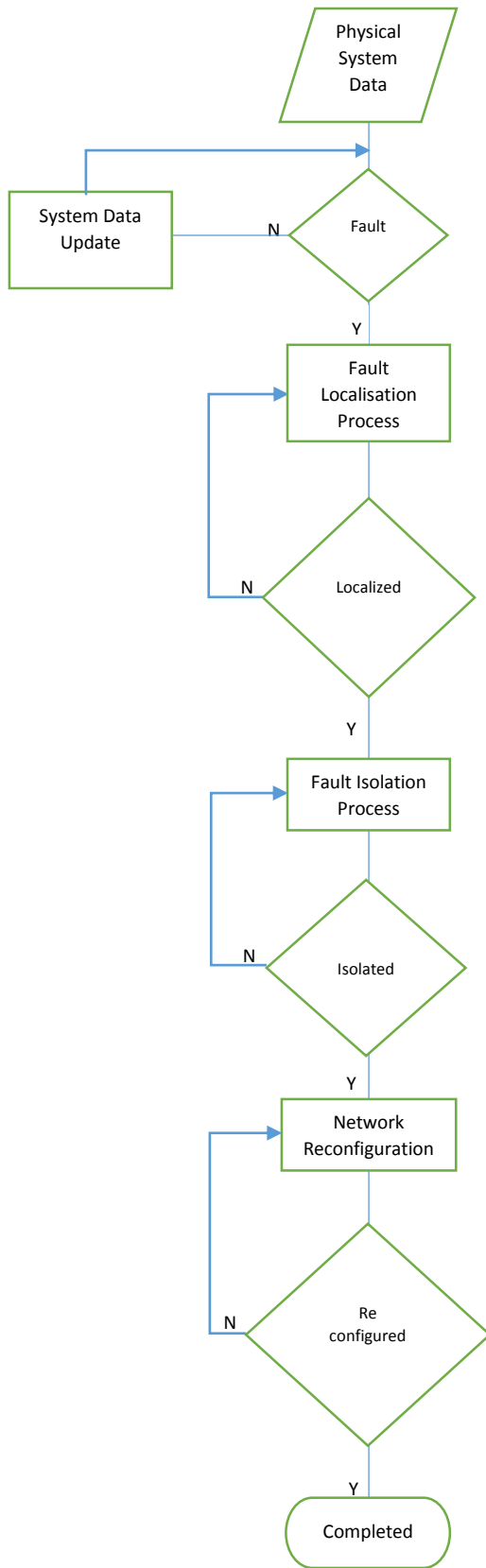

Figure 4.6: Flow chart of Main Processes

4.3.1. System Data Update

Each LBS send ACL messages to relevant agent at MAS via socket proxy tunnel. When the load break switch communication software comes to its periodic time out, it sends ACL message to its agent informing the operation parameters. This process is describes in the figure 4.7. The system extract the operating current details to update the average operating current parameter.

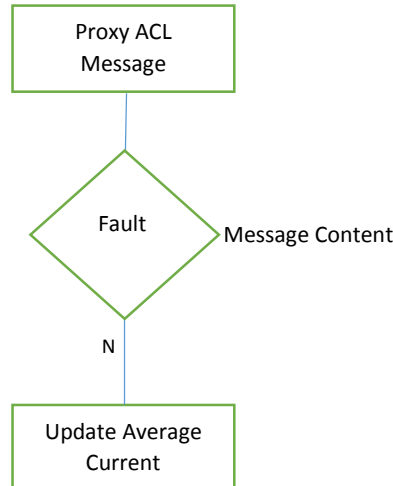

Figure 4.7: System Update Process

The system update process update the average current according to the below equation,

$$\text{Average Current} = \frac{\text{Average Current} + \text{Operating Current}}{2}$$

When an ACL message receives to any of agent, it filter the message using message template and forward them for further processing. In this design message templates were heavily used to make the communication effective.

For the communication via socket proxy tunnel, it is used a message template for the both messages types described above. The message template implementation is shown in figure 4.8.

In this message template the *performative* is set as “*ACLMessage.PROXY*” and conversation-ID is set as “State-Inquiry”. At the message content it forward the status either faulty or good. Then the current value will be taken for the further processing. The calculated average current is an important parameter in negotiations for fault restorations.

```

src\DistributionSystem\LoadBreakSwitch.java
186 //PROXY SOCKET MESSAGE EXCHANGE TEMPLATE
187 MessageTemplate Prxytemp=MessageTemplate.and(
188     MessageTemplate.MatchPerformative(ACLMessage.PROXY),
189     MessageTemplate.MatchConversationId("State-Inquiry"));

```

Figure 4.8: Proxy Message Template

4.3.2. Fault Localization Process

At the process of fault localization it is very important to study about the behaviour of the system parameters during a fault. A typical fault situation in a radial feeder is illustrated in figure 4.9. According to the figure, the fault is occurred between breaker D and E.

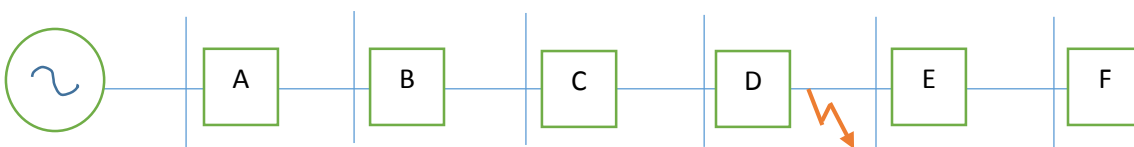

Figure 4.9: Fault incident at Radial Feeder

Once this fault occurred, entire feeder get tripped at the primary substation end experiencing a loss of voltage to the entire feeder. The fault current should flow only through the breaker A, B, C, D. Then at an event of system fault, each breaker experiencing either fault current or normal current depending on the location of the fault. The voltage and current data experienced to the breakers are tabulated at table 3.

Breaker	Voltage	Current
A	Zero	Fault Current
B	Zero	Fault Current
C	Zero	Fault Current
D	Zero	Fault Current
E	Zero	Normal Current
F	Zero	Normal Current

Table 3: Breaker Voltage, Current at a fault

According to the operating current at the event of a fault, it can be identified the section faulty section, fault upstream section and fault downstream section.

When LBS experiencing voltage loss situation, all the LBS inform to its agent about the voltage loss via an ACL Message as in the template of figure 4.8. Once this message arrived, each agent tag its status either “good” or “bad” considering the current passed through as in table 3.

Then in order to localise the fault, this event is informed to PSS agent by the first LBS of the feeder. This process is illustrated in the flow chart in figure 4.10 and figure 4.11.

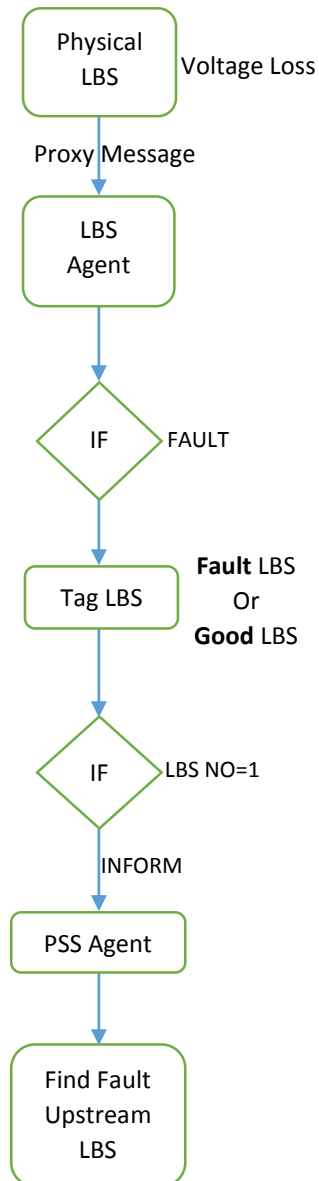

Figure 4.10: Fault inform process

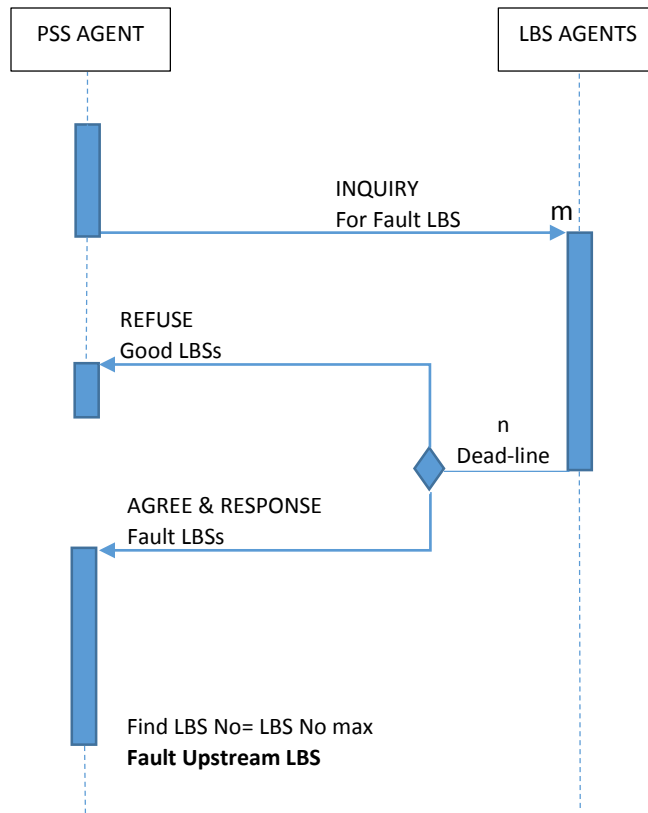

Figure 4.11: Localizing Fault Upstream LBS

The query interaction protocol is illustrated in figure 4.11. When PSS agent get informed about the voltage loss details from the first LBS of that particular feeder, it starts the query interaction messaging for asking about the tag of each of the LBSs.

Here PSS agent finds the below condition to search about the faulty upstream breaker;

$$[\text{LBS}_{\text{Tag=faulty}}]\text{Max No} > \text{Faulty LBS No}$$

The PSS agent evaluates the responses from the faulty LBSs and finds the highest indexed faulty LBS and decides it as the faulty upstream LBS.

This fault upstream LBS number will be used for the fault isolation and network reconfigurations as explained at proceeding sections.

4.3.3. Fault Isolation

Once the PSS agent inform about the ‘fault upstream LBS’ to the feeder agent, feeder agent should isolate the fault section before proceeding to the next steps. As in the case figure 4.9 the fault between D and should be isolated.

The figure 4.12 illustrate the fault isolation flow diagram. Once the feeder agent get informed about the ‘fault upstream breaker’, it starts fault isolation interaction protocol to command the LBSs to isolate the fault. Fault isolation interaction protocol is illustrated in figure 4.13.

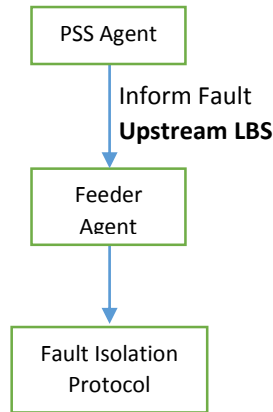

Figure 4.12: Fault Isolation Flow Diagram

In the fault isolation interaction protocol, feeder agent send ACL message to fault upstream breaker and its very next breaker to switch off the LBS and tag them as ‘faulty’.

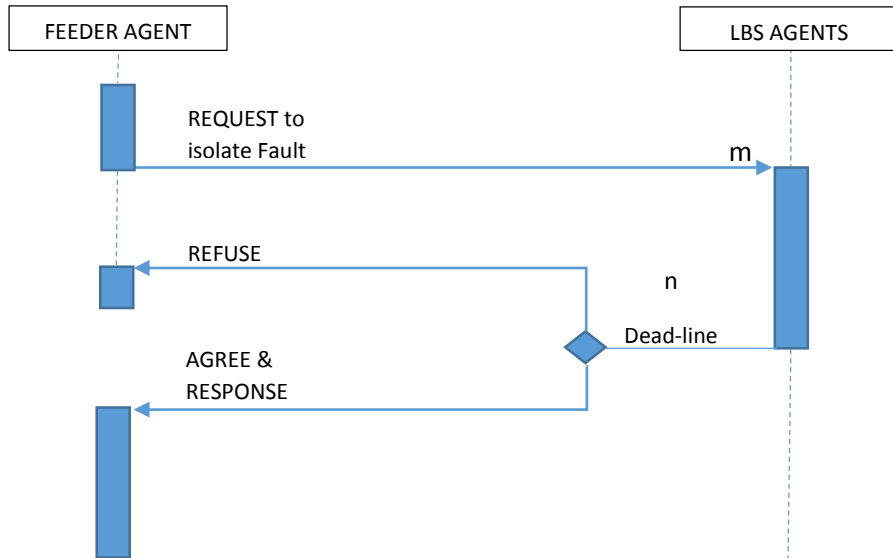

Figure 4.13: Fault Isolation Interaction Protocol

4.3.4. Network Reconfiguration

Once the feeder completed the process of fault isolation, it starts the process of network reconfiguration. Today's power distribution network reconfiguration has numerous proposals, and it is needed to find best proposal out of them all for the better implementation. Making more options for the restoration ease the management of the power distribution network and at the same time it makes the system more complex problem to solve. Therefore in Network reconfiguration, it can identify broad two areas as shown in figure 4.14. Those sections are;

1. Proposal Negotiation and Evaluation
2. Network Rearrangement

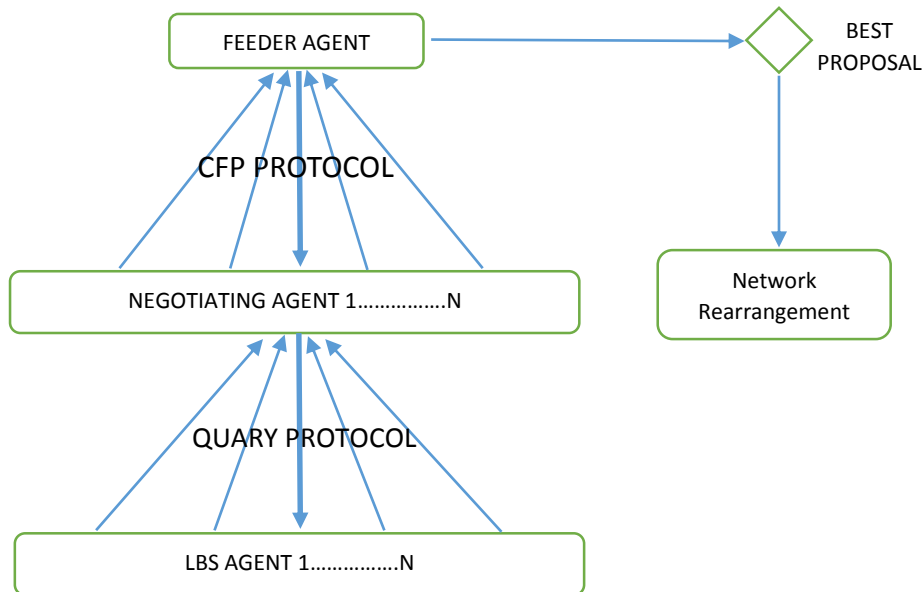

Figure 4.14: Network Reconfiguration flow diagram

Proposal Negotiation and Evaluation

Feeder agent isolates the fault occurred at the feeder by using the fault upstream breaker as described in the section 3.5.4. At the starting of finding the best proposal for restoration, feeder agent finds the negotiating agents connected with the feeder. Negotiating agent is an agent for the feeder interconnection LBS. In the figure 4.5 for agent conceptualisation, it can be seen for the interconnection LBS KL25 between KOORG and KOVHM, LBSs KL26 & KL27 between

KOVHM and KOWEL, LBS KL29 between KOVHM and KOIDH, KL28 between KOWEL and KOIDH. These LBS are used to provide power from other feeder to use at power restoration plan. Then during a fault at a feeder, it send invitation to the negotiating agents to submit their proposal to evaluate the best proposals. This is implemented using contract net interaction protocol as shown in figure 4.15.

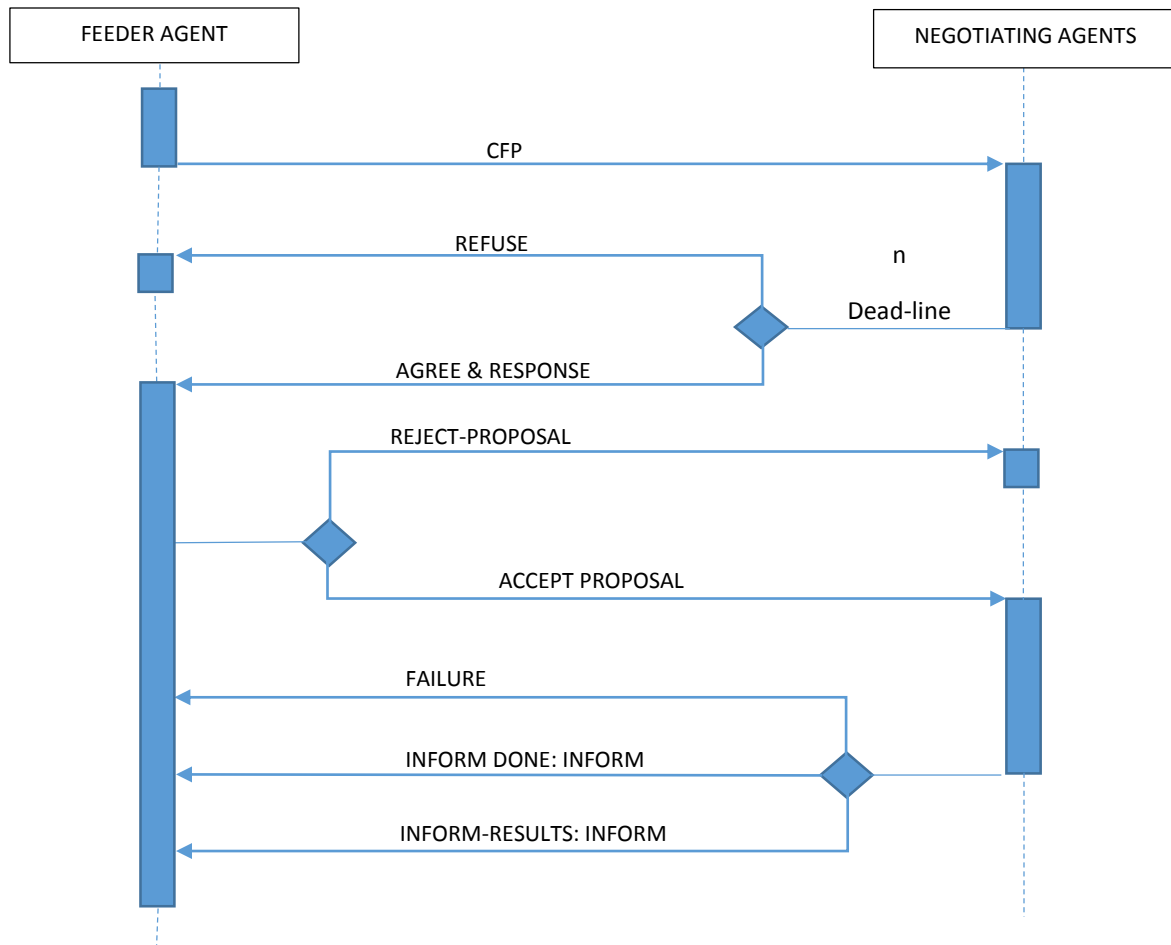

Figure 4.15: Contract-net protocol for evaluation restoration proposals

In the contract net protocol when invitation came from the feeder agent, each negotiating agent needs to find the available power through the negotiating agent. In order to check the available power, the negotiating agent need to check below criteria.

1. Primary Substation Limitation

The total power flow from the primary substation should be equal or less than the primary substation capacity as mentioned in below condition.

$$\sum_{i=0}^n P_i \leq G_i$$

In this condition P is the power flow at each feeder and G is the limitation of the primary substation. Therefore the summation of each feeder load should satisfy the primary substation capacity.

2. Feeder Limitation

The power flow through the feeder, each section, each LBS should be below their limitations such as maximum current flow through feeder conductor, maximum limitation of LBS. Therefore when searching for available power it is needed to satisfy below condition,

$$|P| \leq U$$

Here the P is the power flow through the feeder section and U indicate the limitation of that feeder. Therefore when finding the available power this condition has to be checked at each LBS.

The negotiating agent initiate conversation with LBSs to check above conditions using rational initiator protocol as illustrated in figure 4.16.

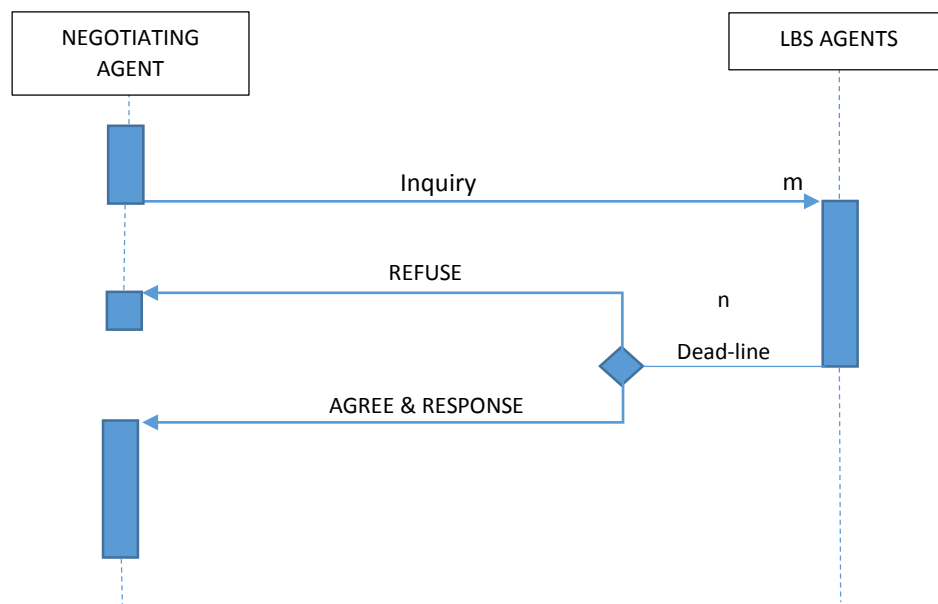

Figure 4.16: Search for available Power

Negotiating agent sends ACL messages to the LBS to inquire about its available power. Then negotiating agent evaluates each responses from LBS and finds the available power that can be provided to restore the fault at the faulty feeder. The communication pattern implemented in an event of fault is illustrated in figure 4.17.

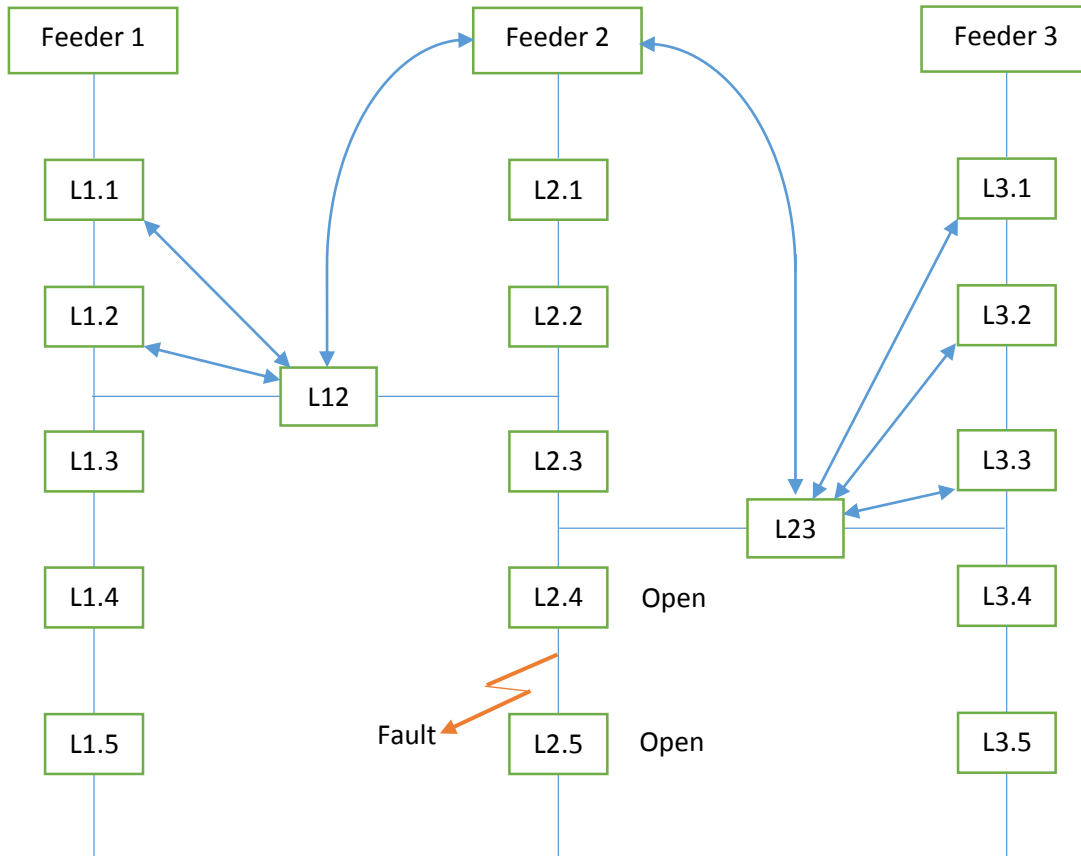

Figure 4.17: Communication Pattern in the event of fault

When negotiating agent inquires about the available power from each LBS, it calculates the available power with above mentioned limitations. These received “*available power*” values will be used to calculate the available power of the negotiating agent according to the below mentioned condition. Then the available power at each LBS sent back to negotiating agent. The available power of the negotiating agent is selected according to below condition,

$$[P_{Available}]_{NEGO.A} = Min. [P_{Available}]_{LBS.A}$$

The minimum power available from the each LBS responses is selected as the available power from the negotiating agent.

Then the negotiating agent send back the available power to the feeder agent for the restorations. The feeder agent collect all proposal from feeder agent and priorities them in descending order.

Network restorations are two categories in full restoration and partial restoration. In the full restoration single proposal can cater to full restoration and in partial restoration it can only be restored a part of a power interrupted area and it is needed to evaluate again for the remaining restoration. Here it is only considered the full restoration case as currently Sri Lankan distribution system familiar with the full restoration with load shedding.

Network Rearrangement

Once the feeder agent select the best proposal from the negotiating agents and if the selected proposal is sufficient to full restoration, feeder agent inform negotiating agent to close the negotiating LBS. Once the negotiating agent responded with the successfully closing of negotiating agent, feeder agent communicate with power interrupted LBS agent to close their LBS as using the communication pattern described in figure 4.18.

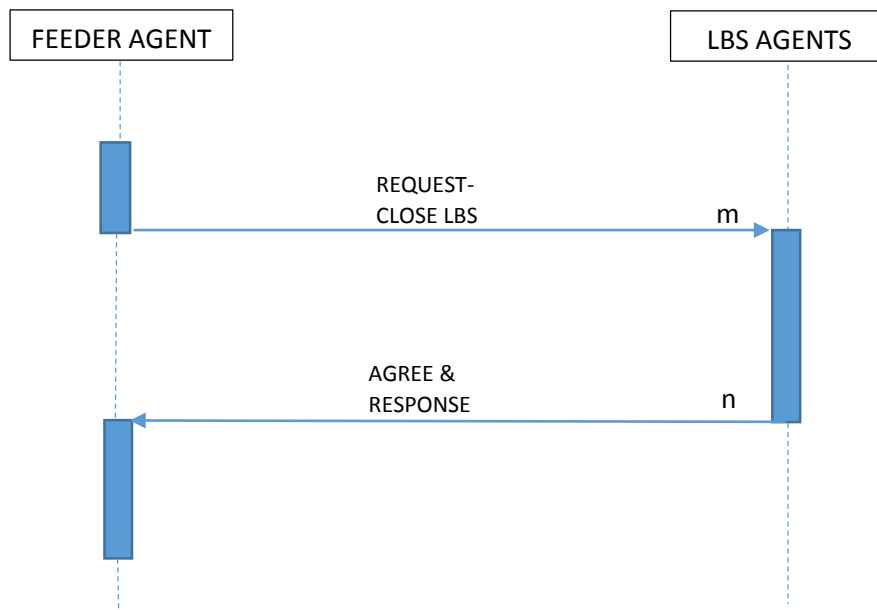

Figure 4.18: Network Rearrangement

The command completion coming from the LBS agent for the LBS close will complete whole process.

4.4. Interface Layer Implementation

JADE communicate with non-JADE applications via socket proxy agent as described in section 2.6.5. A typical ACL message received from multi agent system via socket proxy agent is shown in figure 4.19.

```
(PROXY
:sender ( agent-identifier :name KL1@localhost:1099/JADE :addresses (sequence
http://Aruna:7778/acc ))
:receiver (set ( agent-identifier :name pxyAgent@localhost:1099/JADE :addresses
(sequence http://Aruna:7778/acc )) )
:content "ON"
:reply-with pxyAgent@localhost:1099/JADE1428112974424 :in-reply-to
pxyAgent.pxyAgent-ClientConnection-Thread-47.1428112974415 :conversation-id State-
Inquiry )
```

Figure 4.19: Proxy Message Received to Communication Interface

As shown in the figure 4.19, ACL message is based on message structure with its own key words and syntax. The outside system communicate with jade must parse this formatted message correctly to implement effective communication.

The description of the key words are given in table 1 at the section 2.3.2. The messages sent to Jade system parse it correctly using the jade classes once it sent with the exact format defined by FIPA. From the messages received from jade system, it is needed to extract the content related to the keyword; sender name and content. This is achieved using the regular expression. There are steps to build a regular expression [57],

Identify unique pattern in the string

As given in figure 4.19 the sender details have a common pattern of,

:sender (agent-identifier :name <LBS Name>@

In this sender details only the LBS Name is variable and others are constant fields. And the content field has its common pattern of,

:content "<Content>"

Express Each Pattern as a regular expression

The LBS Name is occurred after the pattern of “:sender (agent-identifier :name” and end before the @ symbol. That can express in regular expressions as,

'(?<=:receiver\s(\s*set\s*(\s*agent-identifier\s*:\s*\s*))\w*'*

The content is occurred after the “:content”, hence it can be expressed as,

'(?<=:content\s+\s+)\w'*

Call the appropriate Search Function

Here it is used to match the given pattern the search function is selected as,

regex(InputData, Expression, 'match')

The search function with expression are given below,

regex(DataRecived, '(?<=:receiver\s(\s*set\s*(\s*agent-identifier\s*:\s*\s*))\w*', 'match')*

regex(DataReceived, '(?<=:content\s+\s+)\w', 'match')*

The regular expression extract the data commands from the MAS and forward it to the physical system. It was implemented a java graphical user interface (GUI) to show the physical environment and status of the LBS as well as to simulate the MAS creating faults at different locations of the distribution system.

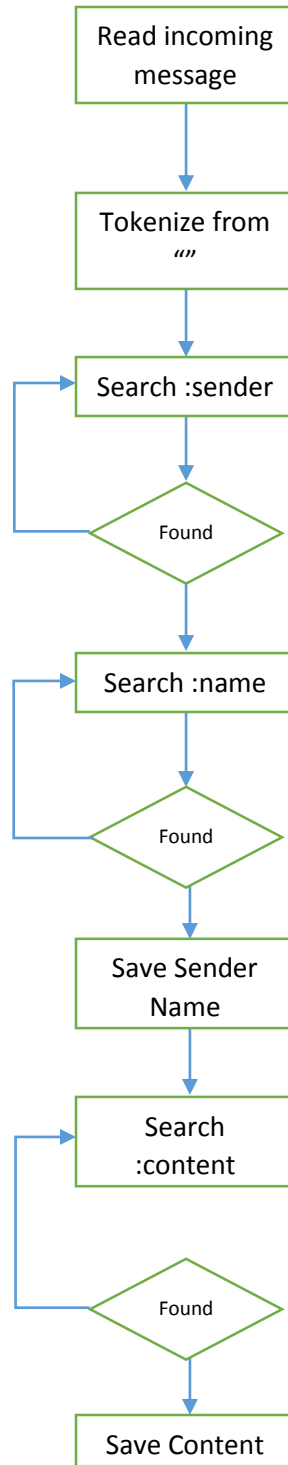

Figure 4.20: ACL Message Parsing Flow diagram

5. RESULT AND VALIDATION

5.1. Agent Creation

Three types of agents used to implement the MAS; PSS agent, feeder agent and LBS agent. The GUI for the LBS agent is shown in figure 5.1.

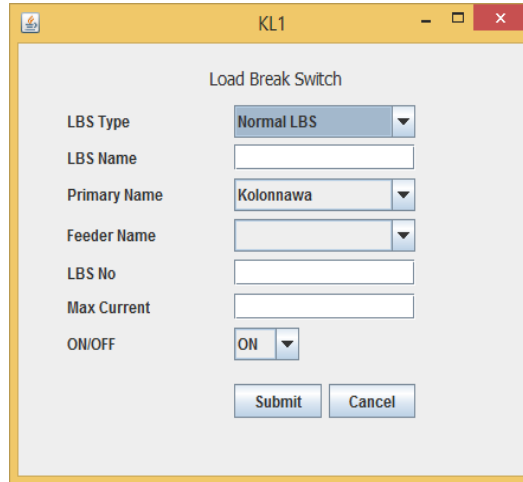
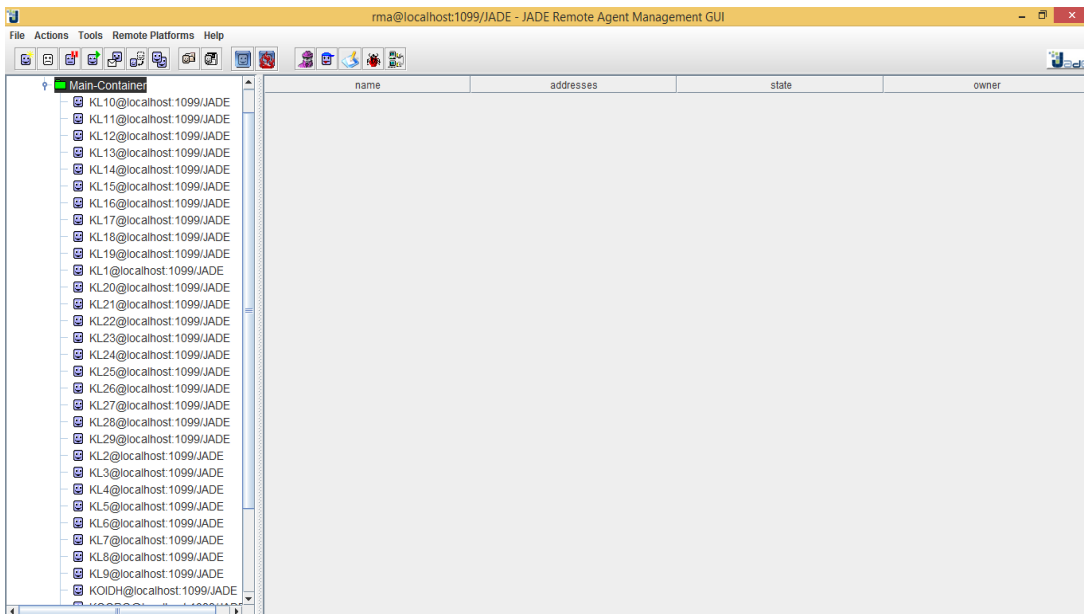

Figure 5.1: LBS Agent GUI

In the system implementation it is needed to create agent per each physical PSS, Feeder and LBS. When it is created in JADE, the remote agent management GUI shows the information of all the created agents and snapshot of it is shown in figure 5.2.



name	addresses	state	owner
KL10@localhost:1099/JADE			
KL11@localhost:1099/JADE			
KL12@localhost:1099/JADE			
KL13@localhost:1099/JADE			
KL14@localhost:1099/JADE			
KL15@localhost:1099/JADE			
KL16@localhost:1099/JADE			
KL17@localhost:1099/JADE			
KL18@localhost:1099/JADE			
KL19@localhost:1099/JADE			
KL1@localhost:1099/JADE			
KL20@localhost:1099/JADE			
KL21@localhost:1099/JADE			
KL22@localhost:1099/JADE			
KL23@localhost:1099/JADE			
KL24@localhost:1099/JADE			
KL25@localhost:1099/JADE			
KL26@localhost:1099/JADE			
KL27@localhost:1099/JADE			
KL28@localhost:1099/JADE			
KL29@localhost:1099/JADE			
KL2@localhost:1099/JADE			
KL3@localhost:1099/JADE			
KL4@localhost:1099/JADE			
KL5@localhost:1099/JADE			
KL6@localhost:1099/JADE			
KL7@localhost:1099/JADE			
KL8@localhost:1099/JADE			
KL9@localhost:1099/JADE			
KOIDH@localhost:1099/JADE			

Figure 5.2: JADE Remote Agent Management GUI

The agent created in MAS is registered in yellow pages and this helps to find related services at the time of fault restoration. Once the agent is created as in figure 5.2 the graphical user interface of directory facilitator is given in figure 5.3.

The screenshot shows the 'Registrations with this DF' tab in the Directory Facilitator GUI. It displays a table with three columns: Agent name, Addresses, and Resolvers. The table lists 28 agents, all with the address 'http://Aruna:7778/acc' and no resolvers listed.

Agent name	Addresses	Resolvers
Kolonnawa@localhost:1099/JADE	http://Aruna:7778/acc	
KL13@localhost:1099/JADE	http://Aruna:7778/acc	
KL3@localhost:1099/JADE	http://Aruna:7778/acc	
KL11@localhost:1099/JADE	http://Aruna:7778/acc	
KL16@localhost:1099/JADE	http://Aruna:7778/acc	
KL8@localhost:1099/JADE	http://Aruna:7778/acc	
KL27@localhost:1099/JADE	http://Aruna:7778/acc	
KL22@localhost:1099/JADE	http://Aruna:7778/acc	
KOORG@localhost:1099/JADE	http://Aruna:7778/acc	
KOVHM@localhost:1099/JADE	http://Aruna:7778/acc	
KL25@localhost:1099/JADE	http://Aruna:7778/acc	
KL2@localhost:1099/JADE	http://Aruna:7778/acc	
KOWMP@localhost:1099/JADE	http://Aruna:7778/acc	
KL20@localhost:1099/JADE	http://Aruna:7778/acc	
KL14@localhost:1099/JADE	http://Aruna:7778/acc	
KL19@localhost:1099/JADE	http://Aruna:7778/acc	
KL5@localhost:1099/JADE	http://Aruna:7778/acc	
KL12@localhost:1099/JADE	http://Aruna:7778/acc	
KL23@localhost:1099/JADE	http://Aruna:7778/acc	
KL4@localhost:1099/JADE	http://Aruna:7778/acc	
KL7@localhost:1099/JADE	http://Aruna:7778/acc	
KL28@localhost:1099/JADE	http://Aruna:7778/acc	
KL17@localhost:1099/JADE	http://Aruna:7778/acc	
KL6@localhost:1099/JADE	http://Aruna:7778/acc	
KL29@localhost:1099/JADE	http://Aruna:7778/acc	
KL10@localhost:1099/JADE	http://Aruna:7778/acc	
KL15@localhost:1099/JADE	http://Aruna:7778/acc	

Figure 5.3: Directory Facilitator GUI

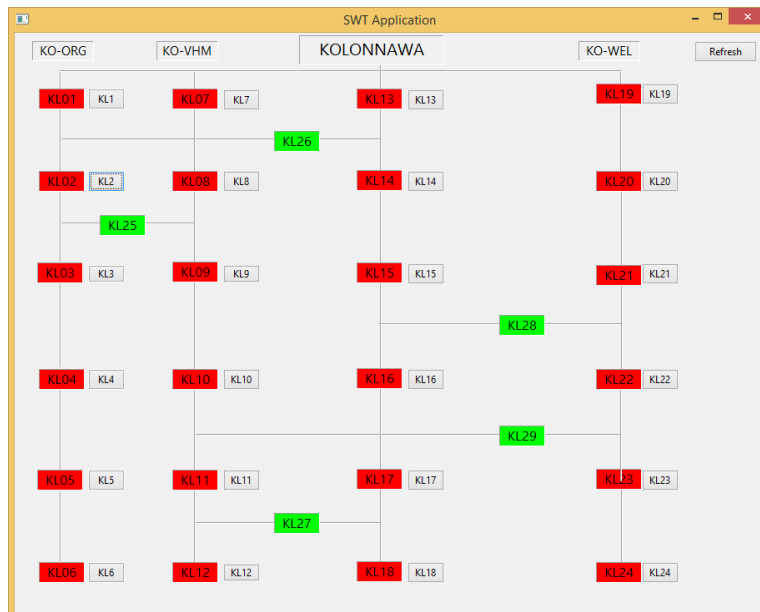

Figure 5.4: Communication Layer GUI

The figure 5.4 shows the initial setup of the distribution network.

5.2. Case Study

This case study is carried out with in one primary substation, where KO-IDH feeder encounter a fault and there are three interconnecting feeders. The available ampere and required ampere values are indicated in figure 5.4.

Primary Substation : 1

Feeders : 4

LBS : 29

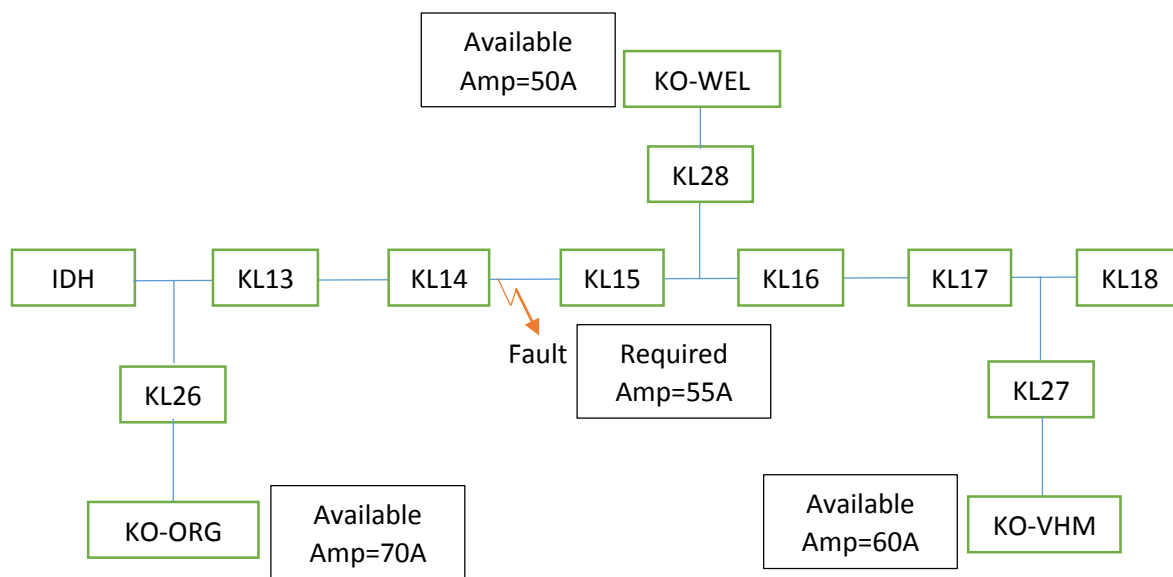

Figure 5.5: Case Study

When the created fault is given to the MAS via communication interface, communication starts among agents.

1. LBS agent KL13-KL18 receives the voltage loss message and KL13, KL14 will receive the fault currents.
2. Primary agent Kolonnawa gets notified about the fault from KL13 and after starting the negotiations, it decides the fault upstream breaker as KL14 and inform the details to KO-IDH feeder agent.
3. KO-IDH feeder agent command KL14 and KL15 to open their LBSs.

4. KO-IDH feeder agent send messages to KL26, KL27 and KL28 to restoration negotiations.
5. KL26 unable to make proposal as it is connected above the fault upstream LBS and KL27 & KL28 reply with available amperes 60A and 50A respectively.
6. Out of above proposals 60A is the best proposal from KL27 and it is below the required ampere. Therefore KO-IDH accept the proposal of KL27 and commands to close the LBS. (in figure 5.6 communication instance of 134 and 136).
7. Then after KO-IDH commands KL13, KL16, KL17 and KL18 to close their LBS to restore the system.

Figure 5.6 shows the part of the communication occurred during the fault restoration and the resulted distribution network is shown in figure 5.7.

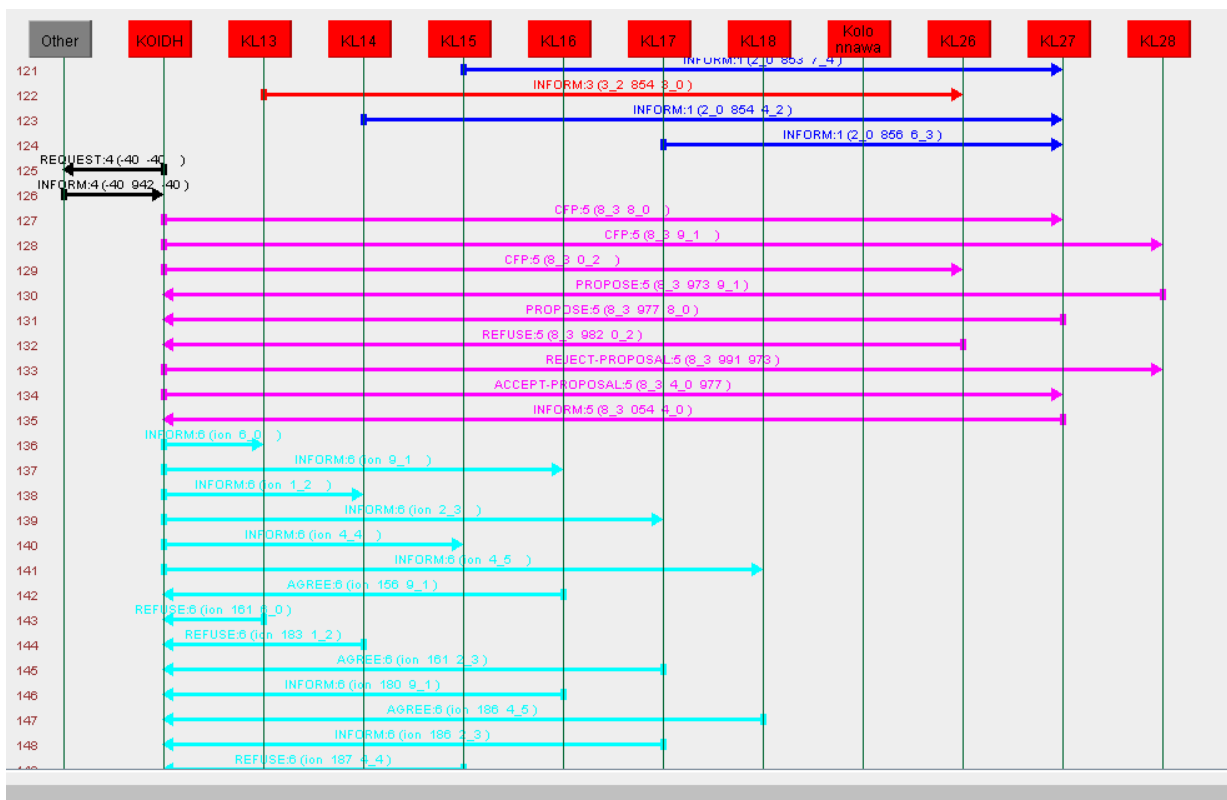

Figure 5.6: ACL Communication for fault restoration

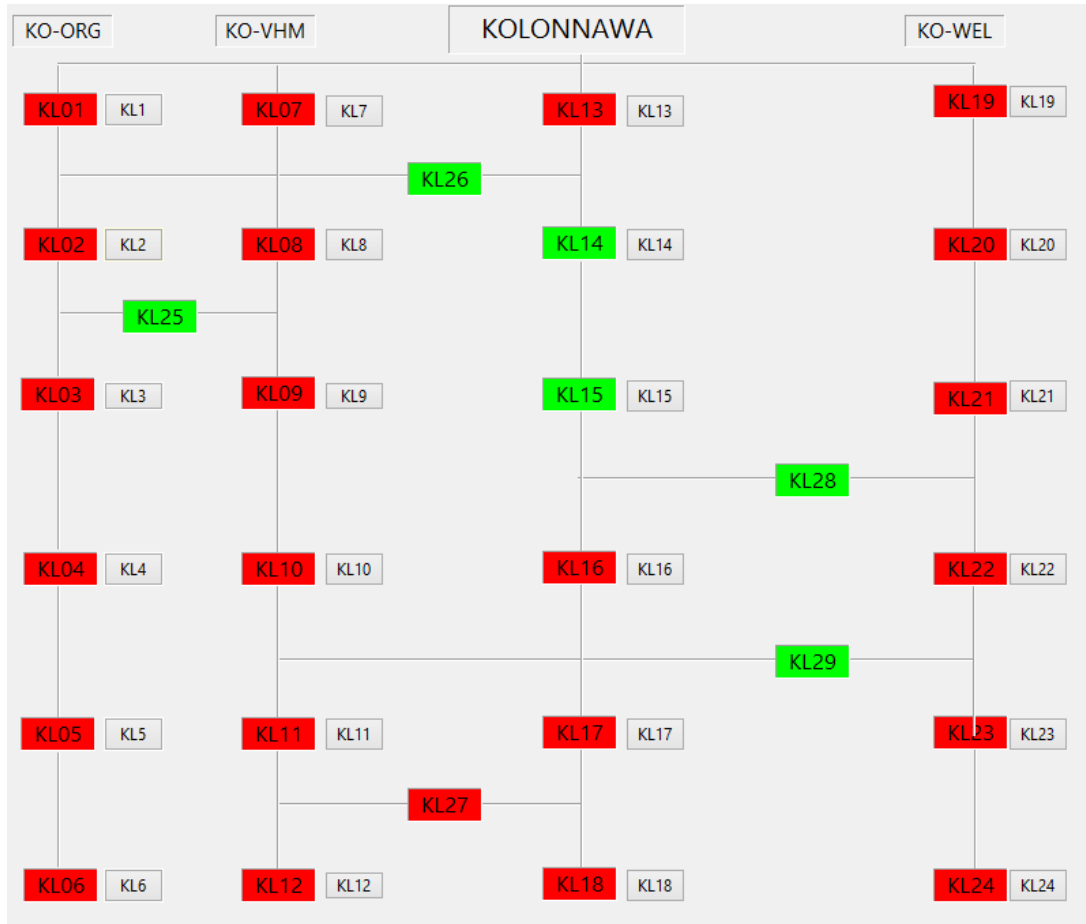

Figure 5.7: Network configuration after the fault restoration of Case

The MAS was tested for the distribution system implemented as shown in figure 5.7. The accuracy and the elapsed time were recorded for the each place of fault creation. The elapsed time were calculated using timer class at java.util package. The current time of the system was found using “System.currentTimeMillis()” function as Start time and End time. The elapsed time is the difference of end time and start time.

The elapsed time was calculated for the JADE method execution and total execution. At the total time calculation, the start time was taken at the time of fault creation and the end time is taken when process completed. The results were summarized in the table 4.

The results shows that the JADE execution takes time below 50 milliseconds and the MAS system communication with external system takes much longer time. However the total time is below 200 milliseconds depending on the stability of the communication.

Fault Occurred		Elapsed Time (ms)		Fault Occurred		Elapsed Time (ms)	
		JADE	TOTAL			JADE	TOTAL
KL1	KL2	37	103	KL13	KL14	31	115
KL2	KL3	33	98	KL14	KL15	37	89
KL3	KL4	33	93	KL15	KL16	32	97
KL4	KL5	33	131	KL16	KL17	37	90
KL5	KL6	33	81	KL17	KL18	33	125
KL7	KL8	34	163	KL19	KL20	34	93
KL8	KL9	35	66	KL20	KL21	29	69
KL9	KL10	45	102	KL21	KL22	41	91
KL10	KL11	47	105	KL22	KL23	33	76
KL11	KL12	33	129	KL23	KL24	33	77

Table 4: Elapsed time of execution Results

For the above illustrated fault scenarios, if conventional technique is used, it would probably take more than couple of hours to localize, isolate and network rearrangement process.

5.3. Physical System Integration

The demonstration board was prepared to validate the system with a physical model. The demonstration board is communicated with MAS via COM port using Arduino Mega 2560 and the board consist of several LED to show the states of LBSs in a power distribution network with two feeders as shown in figure 5.8. Red colour indicate the energized LBS and green colour indicate the de-energized LBS. There are four LBSs at both feeders and one interconnecting breaker as well. The Arduino Mega 2560 is programmed to change digital level for the relevant LED outputs according to the commands given by MAS application.

The physical implementation of demonstration board is shown in figure 5.9 when the system at default operating configuration. The fault scenarios at each LBS level was tested and validate the application of entire system for the use at real world application.

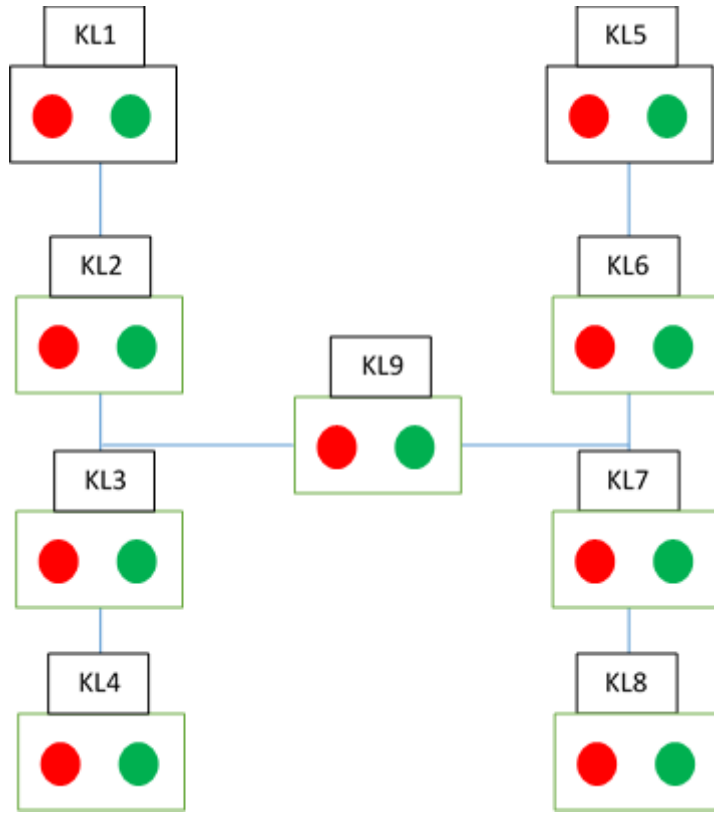

Figure 5.8: Demonstration Board Sketch

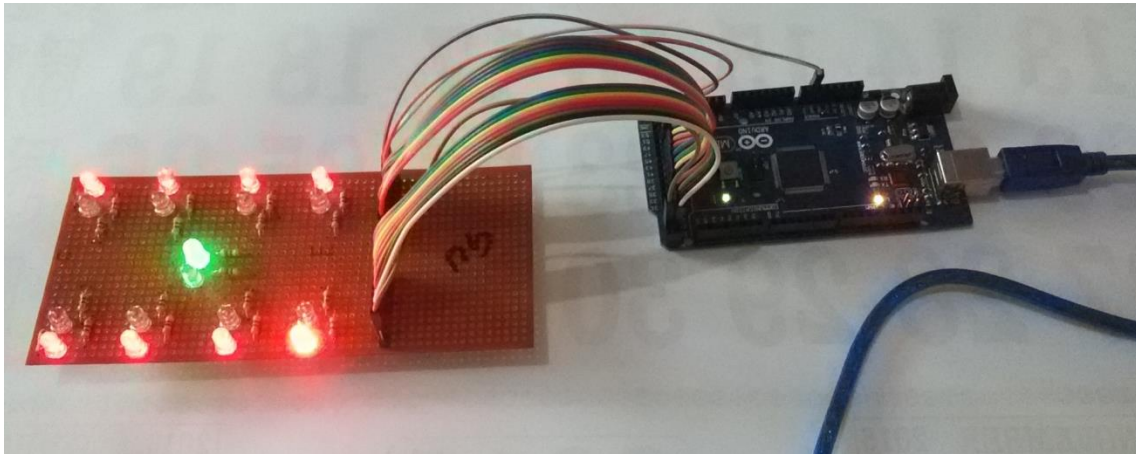

Figure 5.9: Demonstration board in testing environment

6. CONCLUSION

The main objective of the MAS based implementation is to apply the system for fault localization and restoration of power distribution network in Sri Lanka. The JADE was selected as the toolkit for the agent development because JADE is at the front line compared to the other competitive agent development toolkits. JADE provides rich featured methods when implementing the distribution system restoration model. The controlling of agent behaviours are solely done via controlling the agent communication and it is art of the JADE. In the multi agent system model, the agent communication is very vital for effectively implementation of complex system. The interaction protocol based communication and yellow pages service were made the implementation easy. The JADE agents are interacted with outside world via socket proxy tunnel using FIPA formatted messages. But physical equipment and its soft application communication has to be done with the technique as they supported. Therefore there should be a middleware to match the physical world and JADE agent framework. In this implementation, the middleware or communication layer was basically developed using the Java based application and it was tested with Matlab as well. Once the communication layer was developed using java, the system can interact with almost all the system used in world because java provide the protocol support to almost all the systems. Therefore the entire development with application layer and communication layer validate the system for the real world application.

MAS system development involved basically the study of Sri Lankan power distribution network configuration and conventional approaches used for fault localization and restoration. Three agent types were selected which is much closer with distribution power systems. They are primary substation agent, feeder agent and load break switch agent. The behaviour of each agents was implemented by considering the application of each component at the time of power restoration in the conventional system. When the software system implemented closely analogues to the physical system, it is very easier for the system physical launch.

At the real implementation of the system, it is needed to install LBSs with the ability of current, voltage measurement and communicate remotely. The different fault scenarios were tested by assuming the system is with such LBSs and at the event of a fault, it is informed to the MAS system immediately. The resulted optimization times were summarized in table 4. The elapsed time for all the result were in milliseconds where as for the conventional method it took about hours to the

similar results. Therefore compared to the conventional methodology, the proposed system is really fast. But here real comparison has to be done, SCADA based system vs MAS. It is given below the qualitative comparison between typical SCADA system for a distribution network control and the MAS based system.

1. SCADA system comes with fixed sized network whereas MAS based system can be extended to any scaled network because of its inherent distributed nature. Therefore SCADA system has to be upgraded when the distribution system gets upgraded.
2. SCADA systems come as proprietary tools and when the system get expanded it is needed to purchase licence for communication protocols. But MAS is based on the open source JADE under the Lesser General Public License (LGPL) and java based communication layer support well known communication techniques.
3. As SCADA is centralized based solution, it is needed to have more redundancy for the center point to avoid single point of failure. But in MAS based solution does not need much redundancy for avoiding such risk due to its distributed nature.
4. When the distribution network getting larger, SCADA system needs to apply complex algorithms for the optimization problem, whereas in MAS solve the problem using agent inter communication.

Therefore according to the above reasons MAS system is lesser complex and lesser cost. However the both system might provide the result within the similar range of time. But MAS come ahead, when the system become complex. Due to the limitation of socket proxy agent the maximum number of LBS agent that can be handled to a single host is fifty. Therefore at the implementation of LBSs in MAS, it has to be grouped them below fifty number of LBSs under single host and distribute the hosts in geographical map. Then this limitation absorbed to the distributed nature.

Multi Agent System is very flexible system and once the base operating model ensure the accuracy of the application, this can be applied for the large network. Therefore this novel concept can be used to address fault restoration problem in Sri Lankan distribution network successfully.

6.1. Further Improvements

The result table 4 shows that the time taken for the process execution and it shows that communication between MAS and external system consume more time than the process optimization in JADE. Therefore by closely monitoring the communication inefficiencies, it can be improve the total process.

Power system restoration involve different steps such as full restoration, partial restorations, restoration with load shedding etc. In this study it was considered full restoration case with physical implementation, hence further system can be developed to make partial restoration; which involve the restoration using more than one source and restoration with the load shedding.

The general graphical user interface development is an area, which can be developed as further improvement. Currently the agent are launched using JADE rma agent gui and during the larger system implementation, the agent creation and its management has to be simple steps. At the same time it is needed to have user authentication related control center functionalities. Further, the system can be equipped to generate history reports for distribution system maintenance.

In addition, multi agent based system can be link with power system monitoring techniques, metering techniques and them all linking to smarter power distribution network.

References

- [1] CEB, "Transmission Network 2014," Ceylon Electricity Board Sri Lanka, 2012. [Online]. Available: <http://www.ceb.lk/sub/other/networkt.html>.
- [2] C. Byrne, "The super grid. Coming soon to a power outlet near you," 29 Oct 2010. [Online]. Available: <http://venturebeat.com/2010/10/29/super-grid-introduction/>.
- [3] J. M. Solanki, S. Khushalani and N. N. Schulz, "A Multi-Agent Solution to Distribution Systems Restoration," in *Power Systems, IEEE Transactions on (Vol:22, Issue:3)*, Aug, 2007.
- [4] D. Buse, P. Sun, Q. Wu and J. Fitch, "Agent-Based Substation Automation," in *Power and Energy Magazine, IEEE (Volume:1, Issue: 2)*, Mar-Apr 2003.
- [5] F. Bellifemine, G. Caire and D. Greenwood, in *Developing Multi-Agent systems with JADE*, West Sussex, England, Jhon Wiley & Sons Ltd, 2007, pp. 3-74.
- [6] Y. N. Guo, J. Cheng, D. Gong and J. Zhang, "A Novel Multi-agent Based Complex Process Control System and Its Application," *Lecture Notes in Control and Information Sciences, Volume 344*, pp. 319-330, 2006.
- [7] I. Seilonen, T. Pirttioja, P. Appelqvist, K. Koskinen and A. Halme, "Modelling cooperative control in process automation with multi-agent systems," in *Industrial Informatics, 2004. INDIN '04. 2004 2nd IEEE International Conference*, Berlin, 26-26 June 2004.
- [8] Z. Wim, B. Gert, H. R. Van, S. Perica, V. J. V. Der, H. J. Fokko, W. Willem, N. Paul and K. Rene, "Multi-Agent System Control Ontology," in *Third International Symposium, KES-AMSTA 2009*, Uppsala, Sweden, June 2009.
- [9] L. S. Passos, R. J. F. Rossetti and J. Gabriel, "Diagnosis of Unwanted Behaviours in Multi-Agent Systems," in *Faculty of Engineering, University of Porto, Rua Dr. Roberto Frias,, 2009*.
- [10] S. McArthur and E. Davidson, "Multi-agent systems for diagnostic and condition monitoring applications," in *Power Engineering Society General Meeting, 2004, IEEE*, 6-10 June 2004.
- [11] S. McArthur, E. Davidson, J. Hossack and J. McDonald, "Automating power system fault diagnosis through multi-agent system technology," in *System Sciences, 2004. Proceedings of the 37th Annual Hawaii International Conference*, 5-8 Jan. 2004.
- [12] S. Gupta, A. Sarkar and S. Mukherjee, "Implementation Scheme for Clinical Diagnosis System Using Multi-Agent System (MAS)," in *6th International Conference on Information Processing*, Bangalore, India, 10-12 Aug 2012.

- [13] S. Gupta and S. Mukhopadhyay, "Multi Agent System Based Clinical Diagnosis System: An Algorithmic Approach," *Interantional Journal of Engineering Research and Applications Vol 2*, pp. 1474-1477, Sep-Oct 2012.
- [14] N. Sasaki and Y. Dote, "DIAGNOSIS AND CONTROL FOR MULTI-AGENT SYSTEMS USING IMMUNE NETWORKS," *Soft Computing and Industry*, vol. Part I, pp. 3-12, 2002.
- [15] A. Carreraa, C. A. Iglesiasa, J. G. Algarrab and D. Kolarikc, "A real-life application of multi-agent systems for fault diagnosis in the provision of an Internet business service," *Journal of Network and Computer Applications Vol 37*, pp. 146-154, Jan 2014.
- [16] J. Barbosa and P. Leitao, "Simulation of Multi-agent Manufacturing Systems using Agent-based Modelling Platforms," in *Industrial Informatics (INDIN), 2011 9th IEEE International Conference on*, Caparica, Lisbon, July 2011.
- [17] B. S. Germain, P. Valckenaers, H. V. Brussel, Hadeli, O. Bochmann, C. Zamfirescu and P. Verstraete, "MULTI-AGENT MANUFACTURING CONTROL: AN INDUSTRIAL CASE STUDY," *IMS Budapest*, pp. 1-6, 2003.
- [18] L. Monostori, J. Vancza and S. Kumara, "Agent-Based Systems for Manufacturing," *CIRP Annals-Manufacturing Technology*, vol. 55, no. 2, pp. 697-720, 2006.
- [19] T. Wong, C. Leung and H. Tang, "A multi-agent system framework for manufacturing planning and control," in *Intelligent Control and Automation, 2008, WCICA 2008, 7th World Congress*, Chongqing, 25-27 June 2008.
- [20] N. Anand, R. V. Duin and L. Tavasszy, "A SITUATED MULTI-AGENT SYSTEM FOR URBAN FREIGHT IN THE RANDSTAD," in *11th TRAIL Cogress*, Nov 2010.
- [21] H. Franker and W. Dangelmaier, "Decentralized management for transportation-logistics -A Multi Agent based approach," *Integrated Computer-Aided Engineering*, vol. 10, no. 2, pp. 203-210, April 2003.
- [22] V. Graudina and J. Grundspenkins, "Technologies and Multi-Agent System Architectures for Transportation and Logistics Support: An Overview," in *International Conference on Computer System and Technologies CompSysTech 2015*, Jan 2015.
- [23] M. Gath, O. Herzog and S. Edelkamp, "Autonomous and flexible multiagent systems enhance transport logistics," in *Emerging Technologies for a Smarter World(CEWIT), 11th International Conference & Expo*, Melville, NY, 29-30 Oct 2014.
- [24] A. Pokahr, L. Braubach, J. Sudeikat, W. Renz and W. Lamersdorf, "Simulation and Implementation of Logistics Systems based on Agent Technology," in *International Conference on Logistics 2008: Logistics Networks and Nodes*, Hamburg, 2008.

- [25] S. Joel, T. Eiichi and Q. A. Gul, "Evaluating City Logistics Measure in E-Commerce with Multiagent Systems," in *7th International Conference on City Logistics, Vol 39*, Mallorca, Spain, 7-9 June 2011.
- [26] Z. Wang and H. Tianfield, "A Study of Multi-agent System for Network Management," in *International Conference on High Performance Computing and Application*, Shanghai P.R, China, 8-10 Aug 2004.
- [27] M. N. D. Duque, S. M. H. Mejia, I. Gustavo and M. Adriana, "Multi Agent System Implementation for Network Management based on SNMP Protocol," in *International Symposium on Distributed Computing and Artificial Intelligence, Vol 50*, 2008.
- [28] D. Mitrovic, Z. Budimac, M. Ivanovic and M. Vidakovic, "Improving fault Tolerance on Distributed Multi Agent Systems with mobile Network Management Agents," in *International Multi Conference on Computer Science and Information Technology*.
- [29] B. Karima and G. Zahia, "A Multi Agent System for Network Security Management," in *SMARTNET 2000, 6th IFIP Conference on Intelligence in Networks*, Vienna, Austria, Sep 18-22, 2000.
- [30] I. Vlahavas, N. Bassiliades, I. Sakellariou, M. Molina, S. Ossowski, I. Futo, Z. Pasztor, J. Szeredi, I. Velbitskiyi, S. Yershov and I. Netesin, "ExperNet: An Intelligent Multi-Agent System for WAN Management," in *Distributed Expert System for the Management of a National Network*; <http://www.csd.auth.gr/~lpis/projects/inco/Inco.html>.
- [31] FIPA.ORG, FIPA Agent Management Specification- Standard, fab@fipa.org, 2004/18/03.
- [32] FIPA.ORG, FIPA ACL Message Structure Specification- Standard, fab@fipa.org, 2002/12/03.
- [33] FIPA.ORG, FIPA Request Interaction Protocol Specification-Standard, fab@fipa.org, 2002/12/03.
- [34] FIPA.ORG, FIPA Contract Net Interaction Protocol Specification-Standard, fab@fipa.org, 2002/12/03.
- [35] A. Singh, D. Juneja and A. Sharma, "Agent Development Toolkits," in *International Journal of Advancements in Technology*, Jan 2011.
- [36] F. Bellifemine and G. Caire. [Online]. Available: <http://jade.tilab.com/>.
- [37] G. Caire, JADE TUTORIAL-JADE PROGRAMMING FOR BEGINNERS, Free Software Foundation,, June 2009..
- [38] F. Bellifemine, G. Caire, T. Trucco and G. Rimassa, JADE PROGRAMMER'S GUIDE, Free Software Foundation,, April-2010.
- [39] T. Nagata and H. Sasaki, "A Multi-Agent Approach to Power System Restoration," Perth, WA, 2000.
- [40] Y. H. Hsu and H. C. Kuo, "A heuristic based fuzzy reasoning approach for distribution system service restoration," in *Power Delivery, IEEE Transactions on (Vol:9, Issue:2)*, Apr 1994.

- [41] S. Toune, H. Fudo, T. Genji, Y. Fukuyama and Y. Nakanishi, "Comparative study of modern heuristic algorithms to service restoration in distribution systems," in *Power Delivery, IEEE Transactions on (Vol:17, Issue:1)*, Jan 2002.
- [42] F. Gomes, S. Cameiro, J. Pereira, M. Vinagre, P. Garcia and L. Araujo, "A New Heuristic Reconfiguration Algorithm for Large Distribution Systems," in *Power Systems, IEEE Transactions on (Vol: 20, Issue:3)*, Aug.2005.
- [43] A. Morelato and A. Monticelli, "Heuristic search approach to distribution system restoration," in *Power Delivery, IEEE Transactions on (Vol:4, Issue: 4)*, Aug 2002.
- [44] W. Luan, M. Irving and J. Daniel, "Genetic algorithm for supply restoration and optimal load shedding in power system distribution networks," in *Generation, Transmission and Distribution, Vol: 149, Issue:2*, Mar, 2002.
- [45] Y. Kumar, B. Das and J. Sharma, "Multiobjective, Multiconstraint Service Restoration of Electric Power Distribution System With Priority Customers," in *Power Delivery, IEEE Transactions on (Vol:23, Issue:1)*, Jan 2008.
- [46] W. Lin, F. Cheng and M. Tsav, "Distribution feeder reconfiguration with refined genetic algorithm," in *Generation, Transmission and Distribution. Vol:147, Issue: 6*, Nov 2000.
- [47] Y. T. Hsiao and C. Chien, "Enhancement of restoration service in distribution systems using a combination fuzzy-GA method," in *Power System, IEEE Transactions on (Vol:15, Issue:4)*, Nov 2000.
- [48] A. Delbem, A. de Carvalho and N. Bretas, "Main chain representation for evolutionary algorithms applied to distribution system reconfiguration," in *Power Systems, IEEE Transactions on (Vol:20, Issue:1)*, Feb 2005.
- [49] S. D. J. McArthur, E. M. Davidson, V. M. Catterson, A. L. Dimeas, N. D. Hatziargyriou, F. Ponci and T. Funabashi, "Multi-Agent Systems for Power Engineering Applications—Part I: Concepts, Approaches, and Technical Challenges," in *IEEE TRANSACTIONS ON POWER SYSTEMS, VOL:22 No:4*, Nov-2007.
- [50] K. Huang, D. Cartes and S. Srivastava, "A multiagent based algorithm for ring-structured shipboard power system reconfiguration," in *Systems, Man and Cybernetics, 2005 IEEE International Conference on (Volume:1)*, 10-12 Oct. 2005.
- [51] M. Nordman and M. Lehtonen, "An agent concept for managing electrical distribution networks," in *Power Delivery, IEEE Transactions on (Volume:20 , Issue: 2)*, April 2005.
- [52] T. Nagata, Y. Tao and H. Fujita, "An autonomous agent for power system restoration," in *Power Engineering Society General Meeting, 2004. IEEE, Denver, CO*, June 2004.
- [53] L. H. Sun, G. Morejon and D. Cartes, "Interfacing Software Agents with Power System Simulations," in *Proceedings of the 2004 WSEAS Conference, Athens, 2004*.

- [54] H. Liu, L. Zhang, K. Yu and X. Chen, "MAS-Based Restorative Control of Urban Power Network," in *Power and Energy Engineering Conference (APPEEC), 2010 Asia-Pacific*, Chengdu, March 2010.
- [55] P. Parikh, M. Kanabar and T. Sidhu, "Opportunities and challenges of wireless communication technologies for smart grid applications," in *Power and Energy Society General Meeting, 2010 IEEE*, Minneapolis, MN, July 2010.
- [56] ORACLE, "Lesson: Regular Expressions," Oracle, 1995-2014. [Online]. Available: <https://docs.oracle.com/javase/tutorial/essential/regex/>. [Accessed Nov 2014].
- [57] MATHWORKS, "Regular Expressions," MathWorks, Inc., 1994-2014. [Online]. Available: http://in.mathworks.com/help/matlab/matlab_prog/regular-expressions.html. [Accessed Nov 2014].